

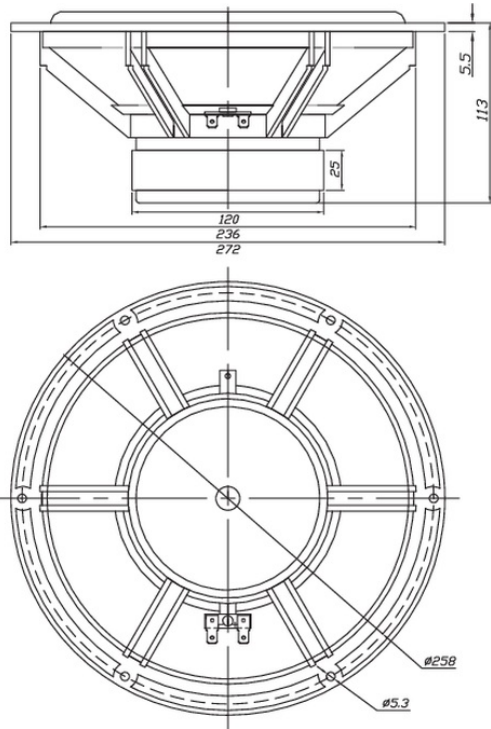

# RS270P-4A 10" Reference Paper Woofer 4 Ohm

RS270P-4A



## PARAMETERS

Impedance	4 ohms
Re	3.9 ohms
Le	0.55 mH
Fs	22.9 Hz
Qms	1.35
Qes	0.34
Qts	0.27
Mms	73.2g
Cms	0.66 mm/N
Sd	346.4 cm <sup>2</sup>
Vd	207.8 cm <sup>3</sup>
BL	10.9 Tm
Vas	110.5 liters
Xmax	6.0 mm
VC Diameter	2"
SPL	90.9 dB @ 2.83V/1m
RMS Power Handling	100 watts
Usable Frequency Range (Hz)	23 - 6,000 Hz

## FEATURES

- Three-part paper composite diaphragm featuring paper, Kevlar, and glass fibers
- Low-distortion high-excursion motor system with two short-circuit paths
- Similar cosmetics and design features as original aluminum Dayton Audio Reference Series
- Perfect for use a woofer, midwoofer, or dedicated midrange driver
- 90.9 dB sensitivity and 6 mm of excursion

## IMPEDANCE/PHASE

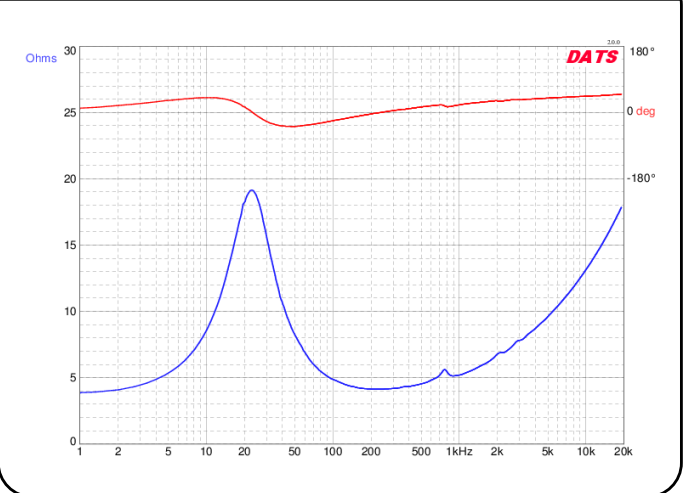

## FREQUENCY RESPONSE

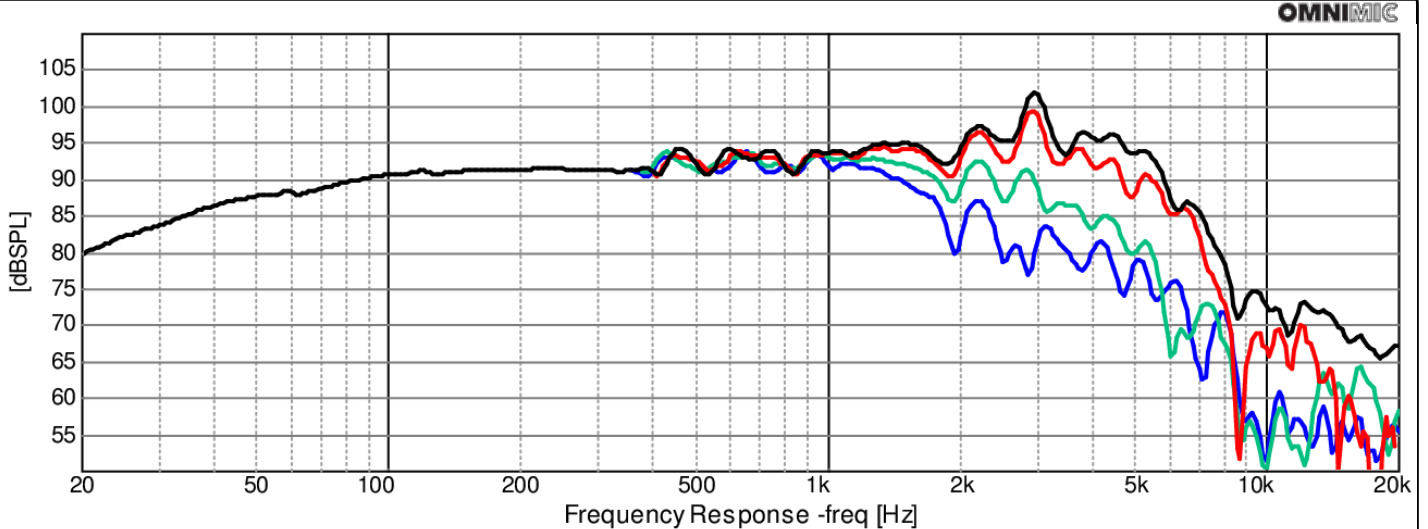

OmniMic

Note: 1/24<sup>th</sup> octave smoothing - nearfield response included in graph below 450 Hz.

Black = 0°  
Red = 15°  
Green = 30°  
Blue = 45°