

SOLEN MURA 5B - SUMMARIZED PLANS

D

C

B

A

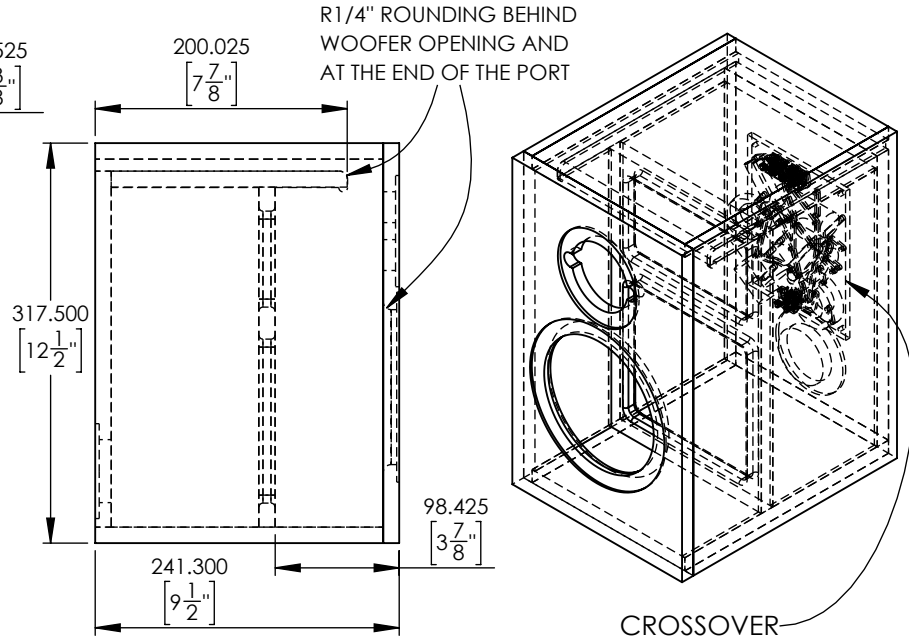
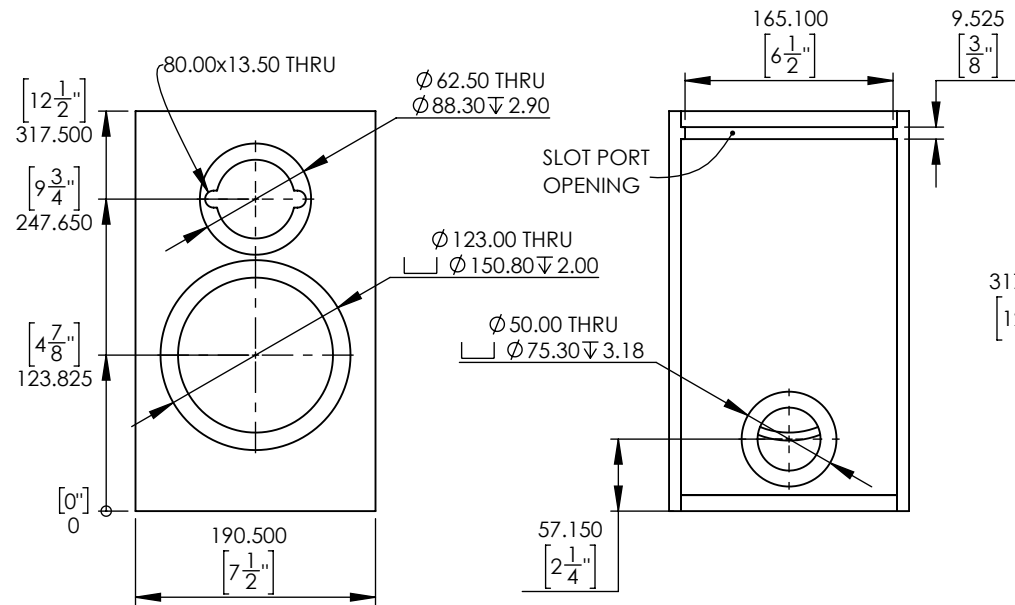

WIRING

WIRING LENGTH TO USE THE ENTIRE 8' OF CABLE THAT COMES WITH THE KIT.
 INPUT : 12" // TWEETER : 18" // WOOFER : 18"

CROSSOVER PARTS LIST

STANDARD

- C1 : PEMT160J825
- C2 : PEMT160J186
- C3 : B05A100K186
- C4 : B05A100K336
- L1 : S20.27 (0.34Ω DCR)
- L2 : S201.0 (0.70Ω DCR)
- L3 : S20.75 (0.60Ω DCR)
- R1 : MO1000J3R6
- R2 : WWSQP10J12R
- R3 : WWSQP10J8R2

PREMIUM



- C1 : PA820
- C2 : PA1800
- C3 : PEMT160J186
- C4 : PEMT160J336
- L1 : S20.27 (0.34Ω DCR)
- L2 : S201.0 (0.70Ω DCR)
- L3 : S20.75 (0.60Ω DCR)
- R1 : AOC1600G3R6
- R2 : MO1000J12R
- R3 : MO1000J8R2

PARTS LIST

- TWEETER : SB Acoustics SB19ST-C000-4
- WOOFER : SB Acoustics SB13PFCR25-8
- CROSSOVER BOARD : MURA 5B v2 CROSSOVER BOARD
- TERMINAL : RPT17GAS
- DAMPING : DAMPING PAD & POLYESTER
- BUILDING MATERIAL : 1/2" MDF

DAMPING PAD INSTALLATION SUGGESTION (OPTIONAL)

- ON THE SIDES IN FRONT AND AT THE BACK OF THE BRACE
- ON THE BACK
- ON THE UNDER SIDE OF THE PORT AT THE BACK OF THE BRACE
- ON THE BOTTOM IN FRONT AND AT THE BACK OF THE BRACE

Legal Owner:  SOLEN ÉLECTRONIQUE INC., 3940 BLVD. SIR-WILFRID-LAURIER, (450) 656-2759 solen@solen.ca	Description: SOLE MURA 5B v2 - SUMMARIZED PLANS	Projection Method: THIRD ANGLE 	
	This drawing and any information or descriptive material set out on it are the confidential and copyright property of Solen Électronique INC. and MUST NOT BE DISCLOSED, COPIED, LOANED in whole or part or used for any purpose without the written permission of Solen Électronique INC.	Drawing Scale: 1:6	All Dimensions: mm [in]
		Material: 1/2" MDF	
		Drawn by: LAURENT TARDIF	
		Drawn Date: 2025-11-20	Sheet Size: LETTER
	Sheet: 1 of 16	Revision: #1	

D

C

B

A

6 5 4 3 2 1

SOLEN MURA 5B SPEAKER KIT - ASSEMBLY INSTRUCTIONS

1. DRIVERS AND INSERTS

POSITION THE DRIVER IN THE BAFFLE AND ORIENT IT THE WAY YOU PREFER AND USE A PUNCH TO MARK THE HOLES LOCATION. DO THE SAME FOR THE TERMINAL AT THE BACK. THEN USE A 1/8" DRILL BIT TO DO THE PILOT HOLES.

MAKE SURE NOT TO OVERTIGHTEN THE SCREWS INTO THE WOOD

2. CABLING

1. CUT THE FT4/16-2 TO AN APPROPRIATE LENGHT (SEE "SUMMARIZED PLAN" PAGE) TO CONNECT THE DRIVERS EASILY ONCE THE CROSSOVER IS INSTALLED IN THE ENCLOSURE.

2. INSTALL THE SPEAKER CONNECTORS ON THE CABLES :

A. WOOFER CABLE : RED=GFD205-1614R // BLACK=GFD110-1614B

B. TWEETER CABLE : RED=GFD205-1614R // BLACK=GFD110-1614B

C. TERMINAL CABLE : RED=GFD205-1614R // BLACK=GFD205-1614B

ONE END OF THE CABLES HAS NO CONNECTORS AS THEY GO IN THE TERMINALS (322GDS) ON THE CROSSOVER BOARD.

3. DAMPING MATERIAL

STUFF A PIECE OF POLYESTER (21"X12") BETWEEN THE CROSSOVER AND THE BRACE.



SCREWS & INSERTS

- 6X3/4P(32x) FOR TWEETER,
WOOFER AND TERMINAL

- 6X1/2P (8x) ARE USED TO FIX THE
CROSSOVER INSIDE THE ENCLOSURE



4. INSTALLING THE PARTS

1. CONNECT ALL THE CABLES ON THEIR RESPECTIVE TERMINALS ON THE CROSSOVER BOARD;
2. SCREW THE CROSSOVER BOARD INSIDE ON THE BOTTOM OF THE CABINET (USING THE 6X3/4). DON'T OVERTIGHTEN THEM.
3. CONNECT THE TWEETER AND SCREW IT IN PLACE (USING THE 6X3/4P);
4. CONNECT THE WOOFER AND SCREW IT IN PLACE (USING THE 6X3/4P);
5. CONNECT THE TERMINAL CONNECTORS AND SCREW IT IN PLACE (USING THE 6X3/4P);

 SOLEN ÉLECTRONIQUE INC. 3940 BLVD. SIR-WILFRID-LAURIER, (450) 656-2759 solen@solen.ca	Legal Owner: SOLEN MURA 5B v2 - ASSEMBLY INSTRUCTIONS	Projection Method:  THIRD ANGLE
	Description: SOLEN MURA 5B v2 - ASSEMBLY INSTRUCTIONS	Drawing Scale: 1:2 All Dimensions: mm [in]
	This drawing and any information or descriptive material set out on it are the confidential and copyright property of Solen Électronique INC. and MUST NOT BE DISCLOSED, COPIED, LOANED in whole or part or used for any purpose without the written permission of Solen Électronique INC.	Material: N/A
		Drawn by: LAURENT TARDIF
		Drawn Date: 2025-11-20 Sheet Size: LETTER Sheet: 2 of 16 Revision: #1

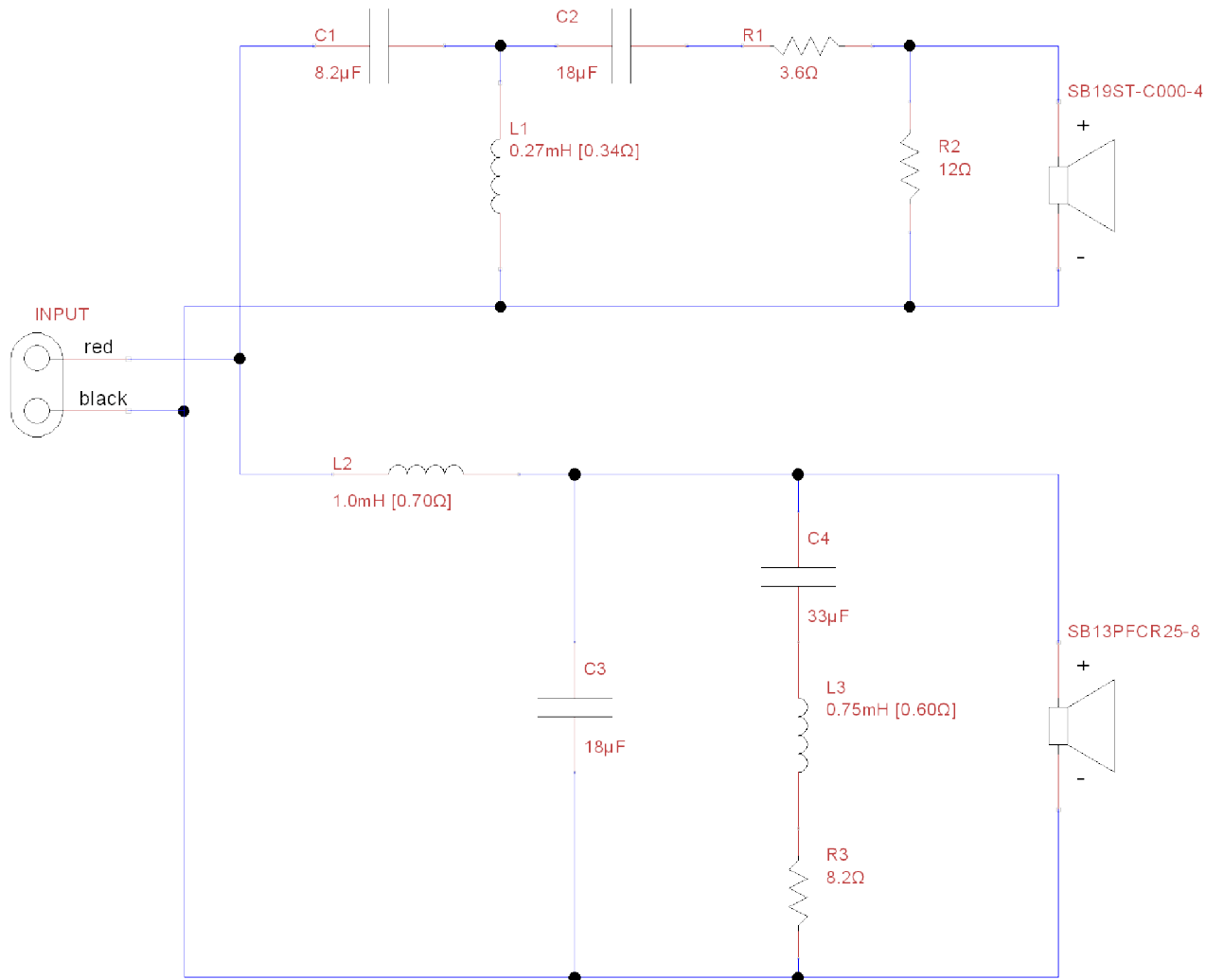
SOLEN MURA 5B - CROSSOVER (1/2)



 SOLEN ÉLECTRONIQUE INC., 3940 BLVD. SIR-WILFRID-LAURIER, (450) 656-2759 solen@solen.ca	Legal Owner: SOLEN ÉLECTRONIQUE INC.	Description: SOLE MURA 5B v2 - CROSSOVER (1/2)	Projection Method: THIRD ANGLE 
	This drawing and any information or descriptive material set out on it are the confidential and copyright property of Solen Électronique INC. and MUST NOT BE DISCLOSED, COPIED, LOANED in whole or part or used for any purpose without the written permission of Solen Électronique INC.		Drawing Scale: 1:1
			All Dimensions: mm [in]
	Material: N/A		
	Drawn by: LAURENT TARDIF		
Drawn Date: 2025-11-20	Sheet Size: LETTER		
Sheet: 3 of 16	Revision: #1		



SOLEN MURA 5B - CROSSOVER (2/2)

NOTES

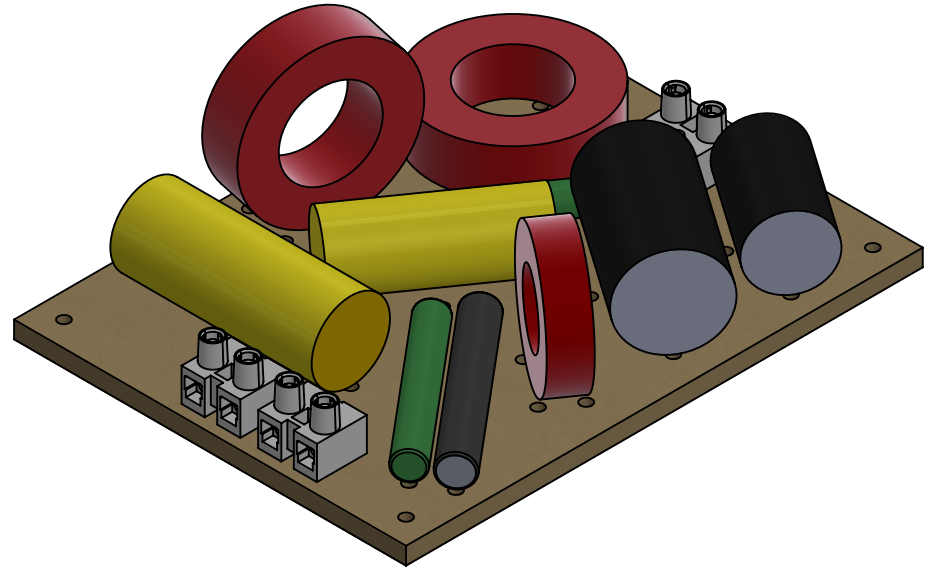
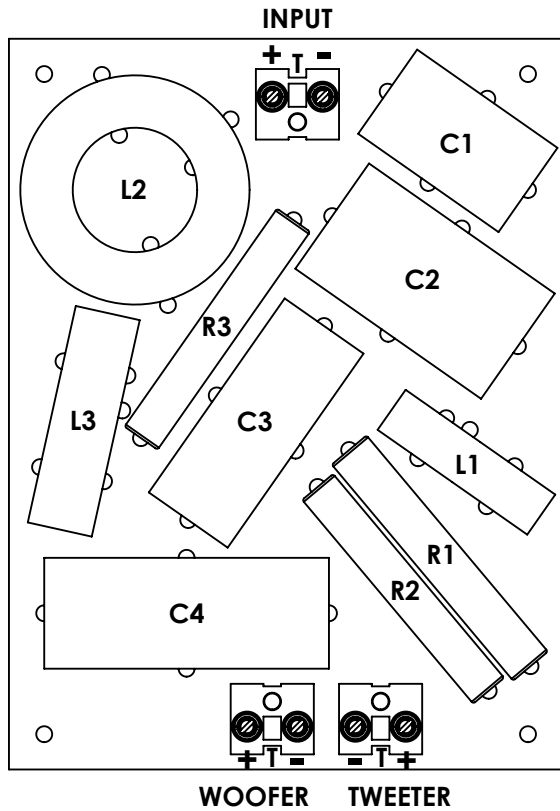
1. USE THE 6X1/2P TO INSTALL THE CROSSOVER INSIDE THE CABINET
2. MAKE SURE THE TIE-WRAPS LOCKING HEAD ON L3 ARE ON THE OUTSIDE OF THE BOARD
3. MAKE SURE TO REMOVE THE RED ENAMEL ON THE INDUCTORS WHERE IT IS SOLDERED
4. USE THE LEFTOVER INDUCTOR WIRES TO CONNECT THE PARTS WHERE THE PARTS WIRING DO NOT REACH EACH OTHER



THE CROSSOVER SHOWN ABOVE IS WITH THE PREMIUM CONFIGURATION



Legal Owner:  SOLEN ÉLECTRONIQUE INC., 3940 BLVD. SIR-WILFRID-LAURIER, (450) 656-2759 solen@solen.ca	Description: SOLE MURA 5B v2 - CROSSOVER	Projection Method: THIRD ANGLE 	
	This drawing and any information or descriptive material set out on it are the confidential and copyright property of Solen Électronique INC. and MUST NOT BE DISCLOSED, COPIED, LOANED in whole or part or used for any purpose without the written permission of Solen Électronique INC.	Drawing Scale: 2:3	All Dimensions: mm [in]
		Material: 4.8mm HDF	
		Drawn by: LAURENT TARDIF	
		Drawn Date: 2025-11-20	Sheet Size: LETTER
	Sheet: 4 of 16	Revision: #1	

SOLEN MURA 5B - CROSSOVER TOP&BOTTOM VIEW

TOP VIEW

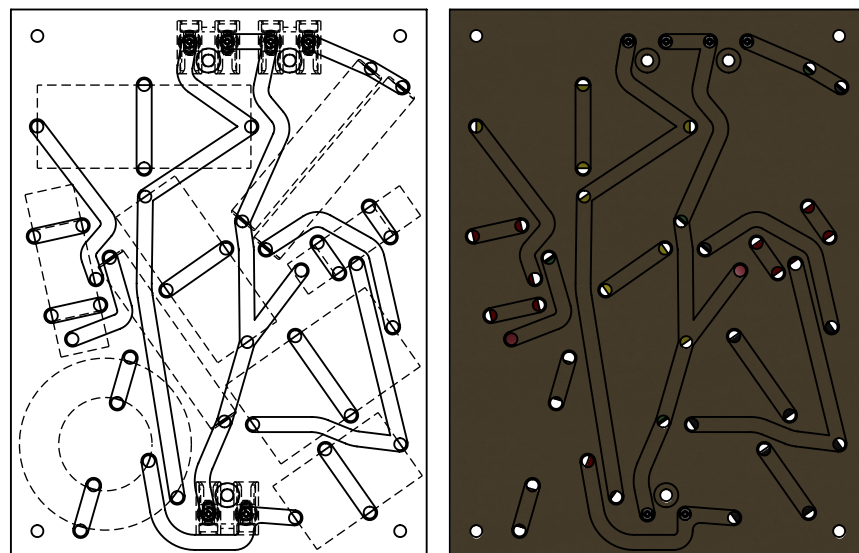
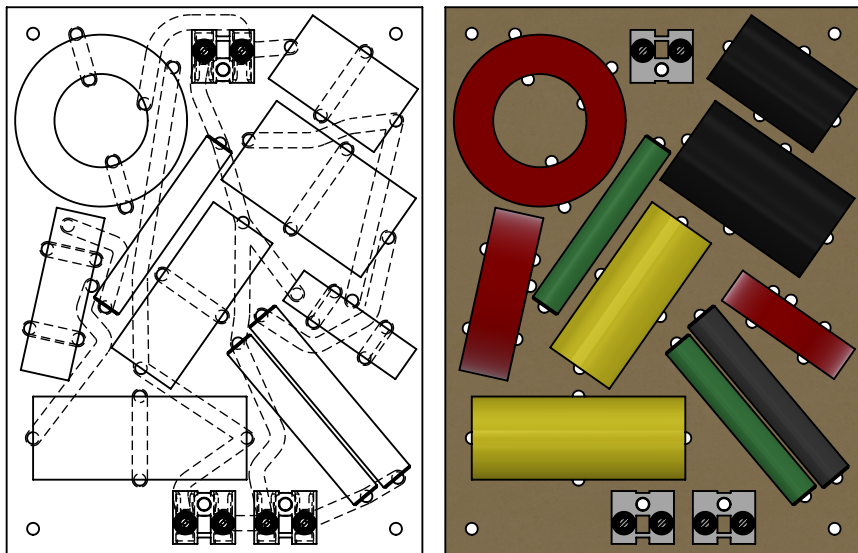

BOTTOM VIEW

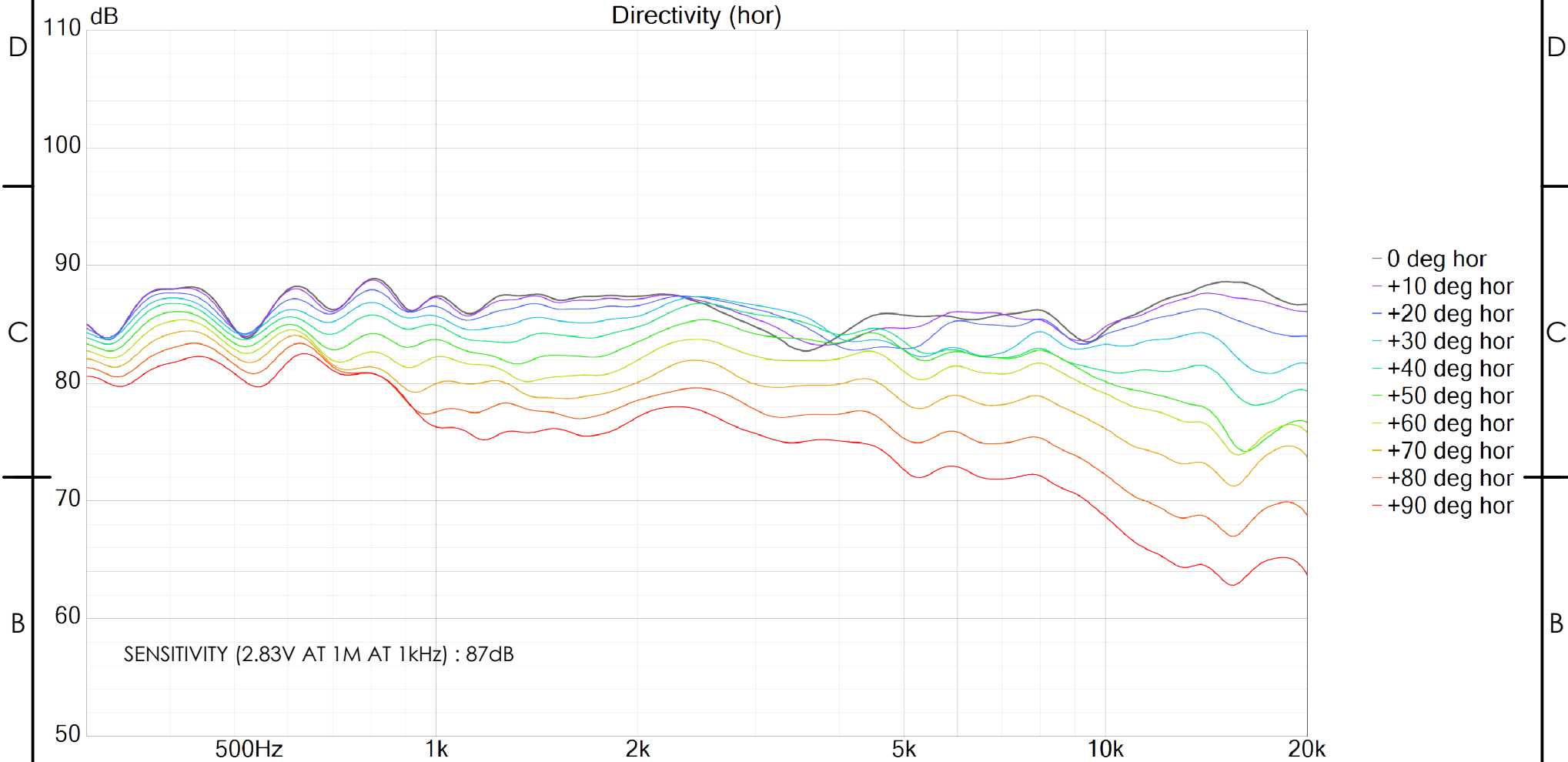

<p>Legal Owner:</p>  <p>SOLEN ÉLECTRONIQUE INC., 3940 BLVD. SIR-WILFRID-LAURIER, (450) 656-2759 solen@solen.ca</p>	<p>Description:</p> <p>SOLEN MURA 5B v2 - CROSSOVER TOP&BOTTOM VIEW</p>	<p>Projection Method:</p> <p>THIRD ANGLE </p>
	<p>This drawing and any information or descriptive material set out on it are the confidential and copyright property of Solen Électronique INC. and MUST NOT BE DISCLOSED, COPIED, LOANED in whole or part or used for any purpose without the written permission of Solen Électronique INC.</p>	<p>Drawing Scale: 1:2</p> <p>All Dimensions: mm [in]</p>
	<p>Material: 4.8mm HDF</p>	
	<p>Drawn by:</p> <p>LAURENT TARDIF</p>	
	<p>Drawn Date:</p> <p>2025-11-20</p>	<p>Sheet Size:</p> <p>LETTER</p>
<p>Sheet: 5 of 16</p>	<p>Revision: #1</p>	

SOLEN MURA 5B - FREQUENCY RESPONSE





<p>Legal Owner:</p>  <p>SOLEN ÉLECTRONIQUE INC. 3940 BLVD. SIR-WILFRID-LAURIER, (450) 656-2759 solen@solen.ca</p>	<p>Description:</p> <p>SOLEN MURA 5B v2 - FREQUENCY RESPONSE</p>	<p>Projection Method:</p> <p>THIRD ANGLE </p>
	<p>This drawing and any information or descriptive material set out on it are the confidential and copyright property of Solen Électronique INC. and MUST NOT BE DISCLOSED, COPIED, LOANED in whole or part or used for any purpose without the written permission of Solen Électronique INC.</p>	<p>Drawing Scale: 1:6</p> <p>All Dimensions: mm [in]</p>
	<p>Material: N/A</p>	<p>Drawn by:</p> <p>LAURENT TARDIF</p>
	<p>Drawn Date:</p> <p>2025-11-20</p>	<p>Sheet Size:</p> <p>LETTER</p>
	<p>Sheet: 6 of 16</p>	<p>Revision: #1</p>

SOLEN MURA 5B - PREDICTED IN-ROOM

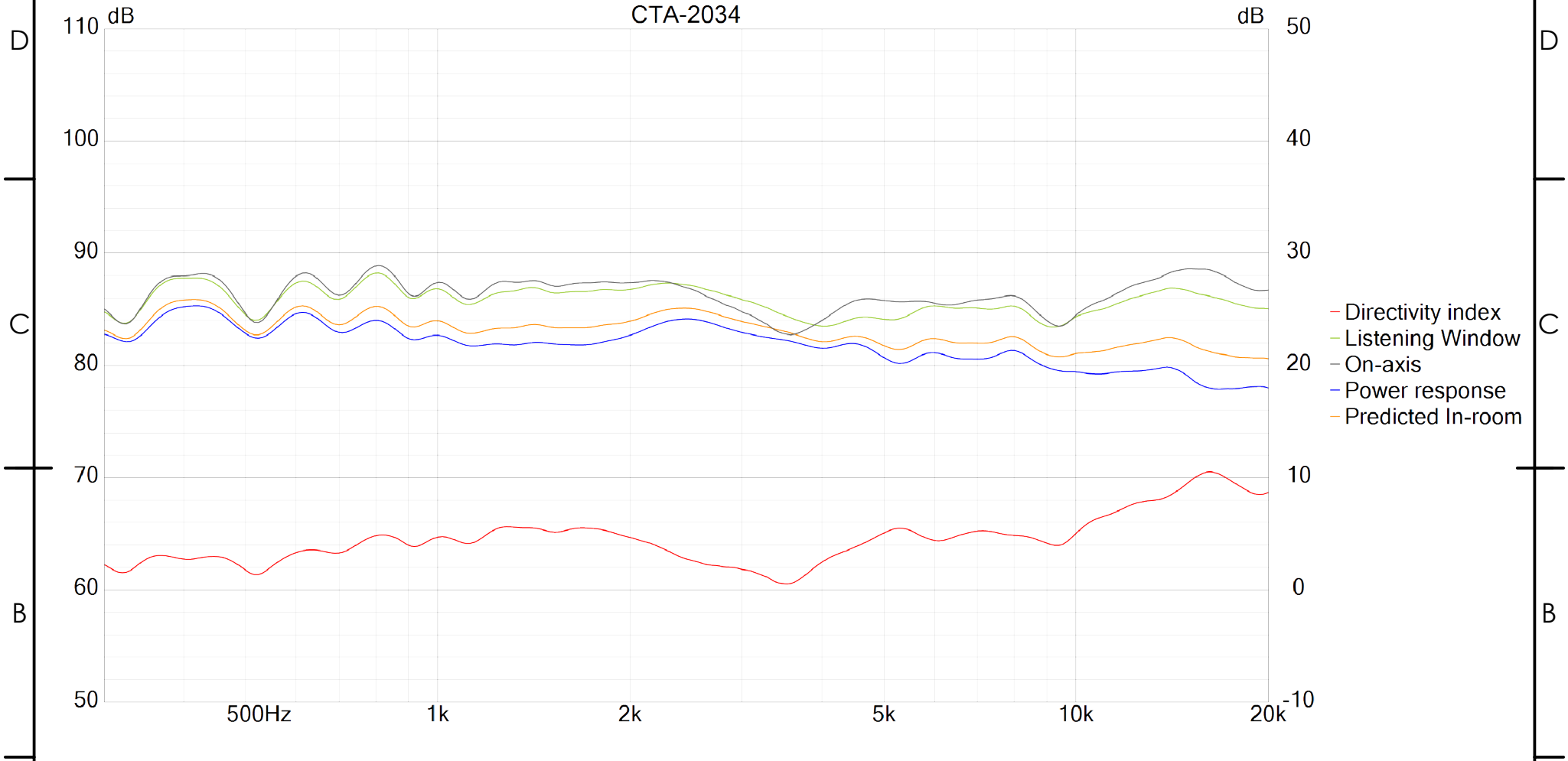
CTA-2034



- Directivity index
- Listening Window
- On-axis
- Power response
- Predicted In-room

<p>Legal Owner:</p>  <p>SOLEN ÉLECTRONIQUE INC., 3940 BLVD. SIR-WILFRID-LAURIER, (450) 656-2759 solen@solen.ca</p>	<p>Description:</p> <p>SOLEN MURA 5B v2 - PREDICTED IN-ROOM</p>	<p>Projection Method:</p> <p>THIRD ANGLE </p>
	<p>This drawing and any information or descriptive material set out on it are the confidential and copyright property of Solen Électronique INC. and MUST NOT BE DISCLOSED, COPIED, LOANED in whole or part or used for any purpose without the written permission of Solen Électronique INC.</p>	<p>Drawing Scale: 1:6</p> <p>All Dimensions: mm [in]</p>
	<p>Material: N/A</p>	<p>Drawn by:</p> <p>LAURENT TARDIF</p>
	<p>Drawn Date:</p> <p>2025-11-20</p>	<p>Sheet Size:</p> <p>LETTER</p>
	<p>Sheet: 7 of 16</p>	<p>Revision: #1</p>

SOLEN MURA 5B - IMPEDANCE

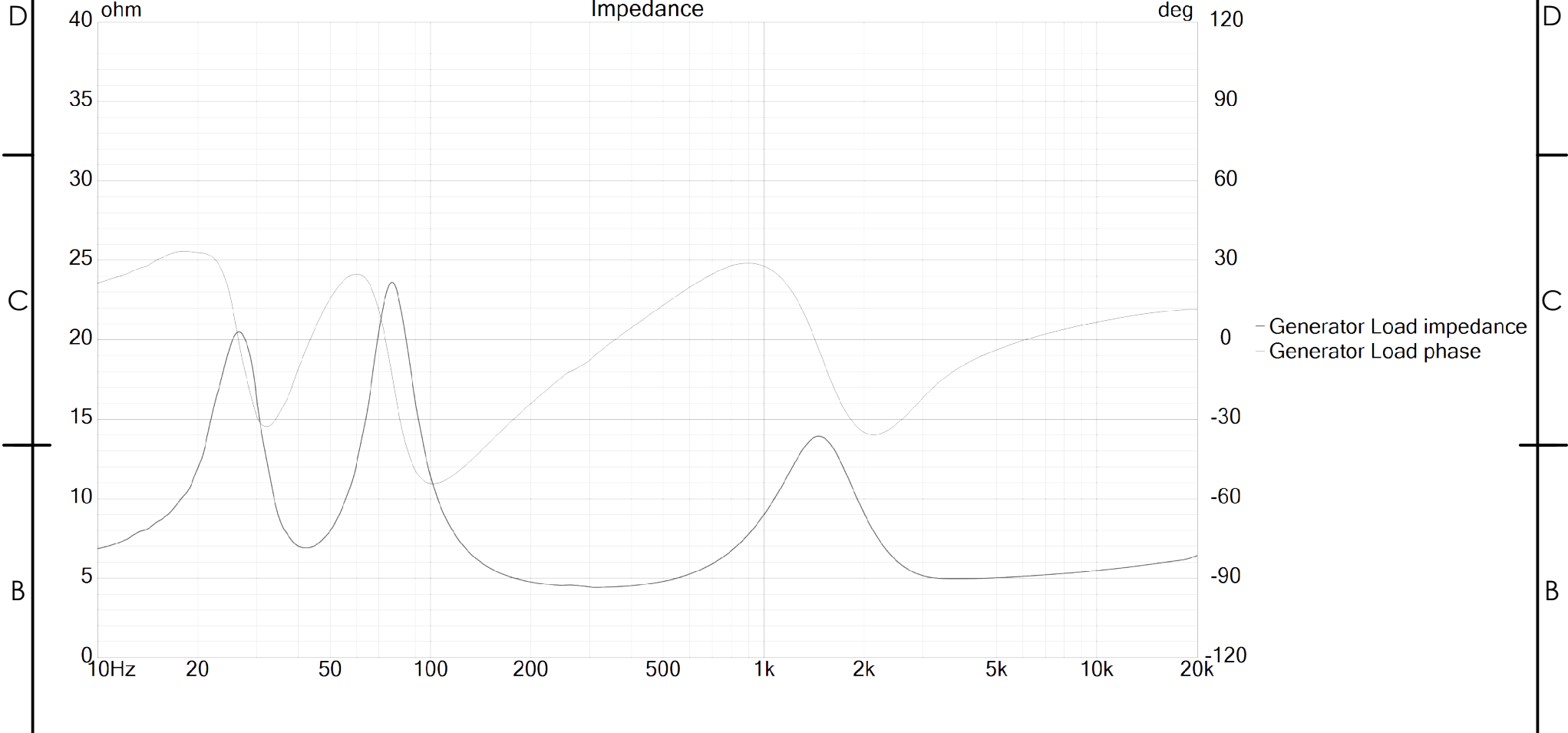

NOMINAL IMPEDANCE : 6Ω
MINIMUM IMPEDANCE : 4.4Ω AT 320Hz

Legal Owner:



SOLEN ÉLECTRONIQUE
INC.,
3940 BLVD. SIR-WILFRID-
LAURIER,
(450) 656-2759
solen@solen.ca

Description:

**SOLEN MURA 5B v2 -
IMPEDANCE**

This drawing and any information
or descriptive material set out on
it are the confidential and
copyright property of Solen
Électronique INC. and MUST
NOT BE DISCLOSED, COPIED,
LOANED in whole or part or
used for any purpose without the
written permission of Solen
Électronique INC.

Projection Method:

THIRD ANGLE



Drawing Scale: **1:6**

All Dimensions:
mm [in]

Material: **N/A**

Drawn by:

LAURENT TARDIF

Drawn Date:

2025-11-20

Sheet Size:

LETTER

Sheet: **8 of 16**



Revision: **#1**

SOLEN MURA 5B - EXPLODED VIEW

D
C
B
A

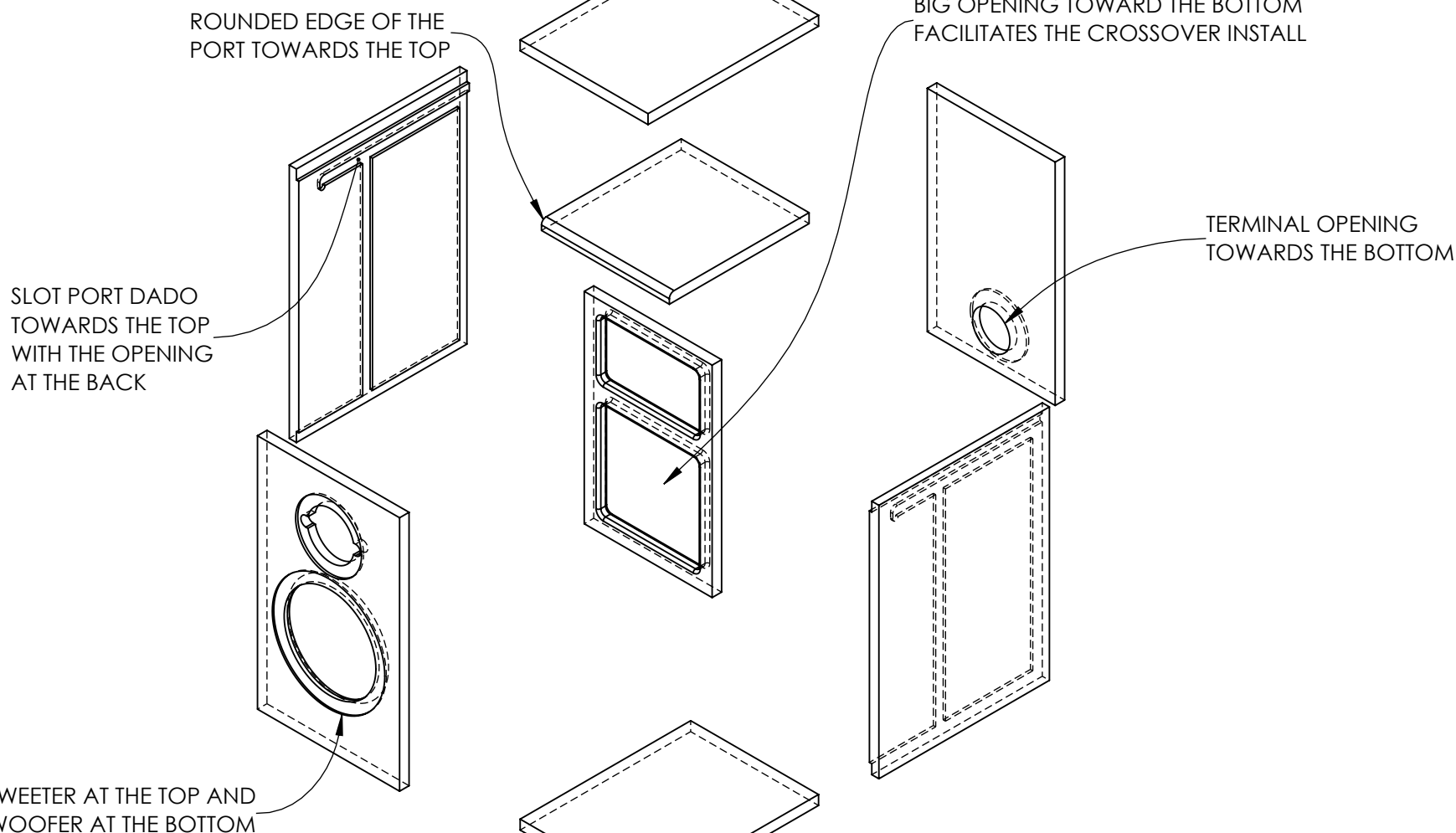
6 5 4 3 2 1





<p>Legal Owner:</p>  <p>SOLEN ÉLECTRONIQUE INC., 3940 BLVD. SIR-WILFRID-LAURIER, (450) 656-2759 solen@solen.ca</p>	<p>Description:</p> <p>SOLEN MURA 5B v2 - EXPLODED VIEW</p>	<p>Projection Method:</p> <p>THIRD ANGLE </p>
	<p>Drawing Scale: 1:6</p>	<p>All Dimensions: mm [in]</p>
	<p>Material: 1/2" MDF</p>	
	<p>Drawn by:</p> <p>LAURENT TARDIF</p>	
	<p>Drawn Date:</p> <p>2026-03-23</p>	<p>Sheet Size:</p> <p>LETTER</p>
<p>Sheet: 9 of 16</p>	<p>Revision: #1</p>	

6 5 4 3 2 1

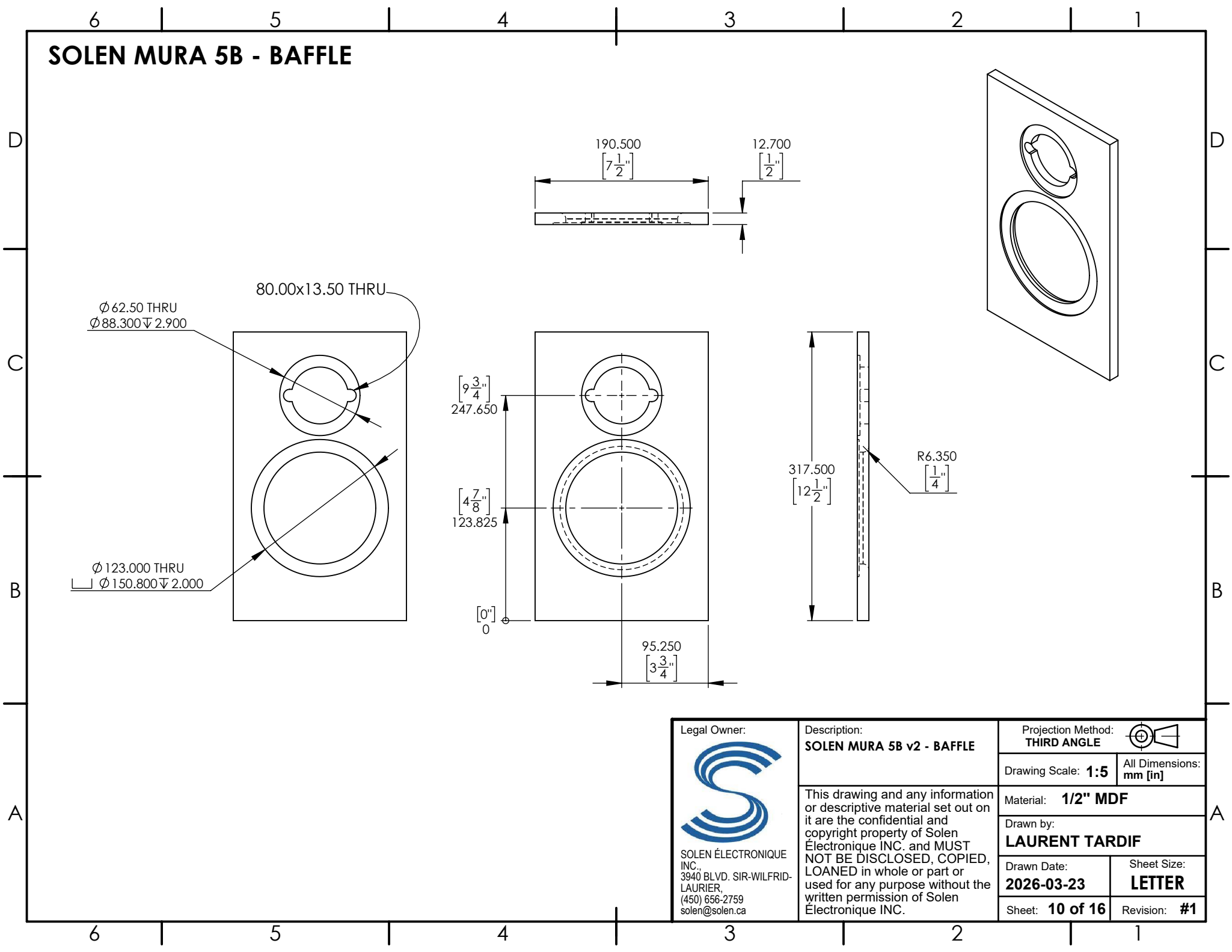
SOLEN MURA 5B - BAFFLE



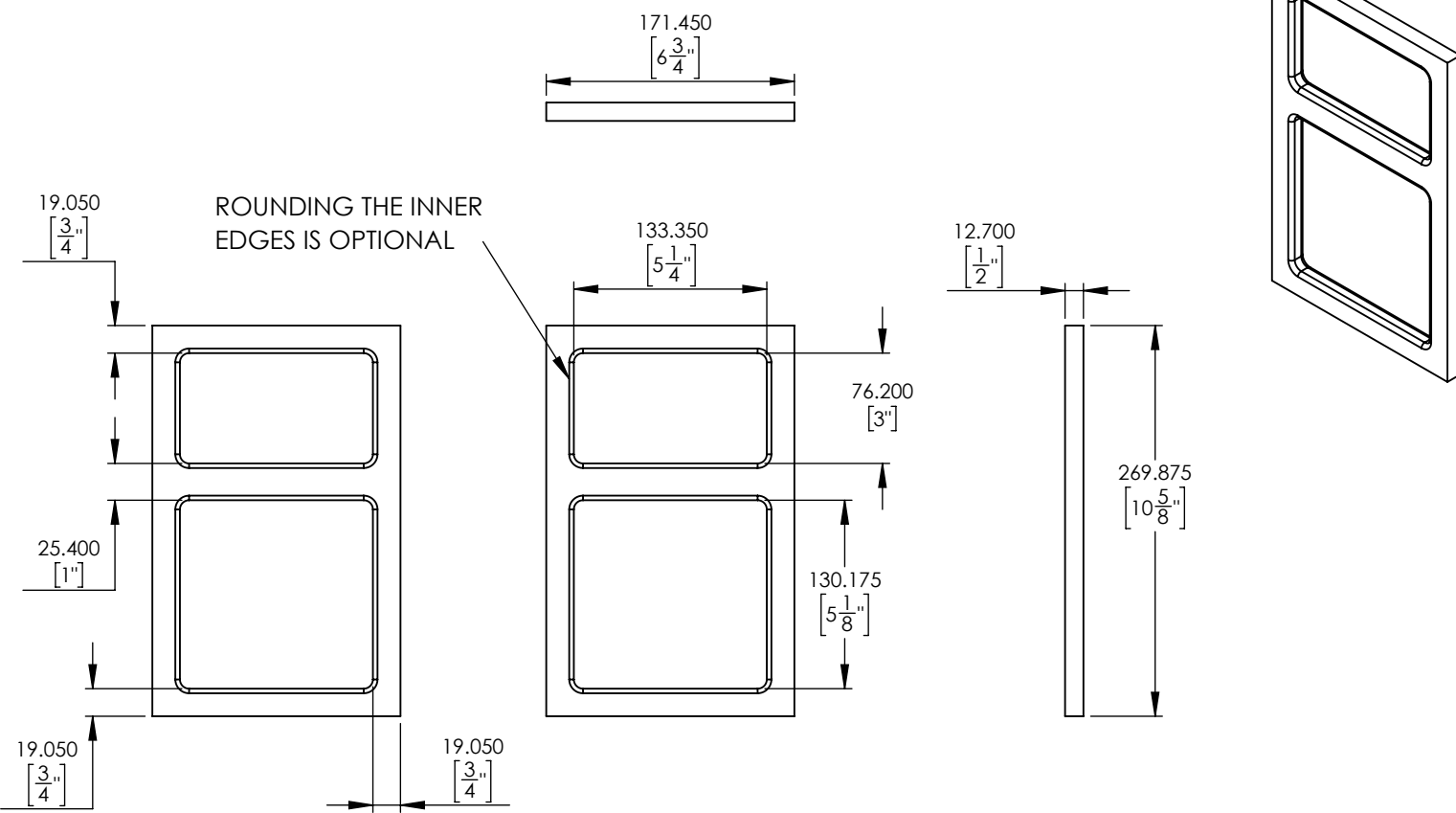

<p>Legal Owner:</p>  <p>SOLEN ÉLECTRONIQUE INC., 3940 BLVD. SIR-WILFRID-LAURIER, (450) 656-2759 solen@solen.ca</p>	<p>Description:</p> <p>SOLEN MURA 5B v2 - BAFFLE</p>	<p>Projection Method:</p> <p>THIRD ANGLE </p>
	<p>Drawing Scale: 1:5</p>	<p>All Dimensions: mm [in]</p>
	<p>Material: 1/2" MDF</p>	
	<p>Drawn by:</p> <p>LAURENT TARDIF</p>	
	<p>Drawn Date:</p> <p>2026-03-23</p>	<p>Sheet Size:</p> <p>LETTER</p>
<p>Sheet: 10 of 16</p>	<p>Revision: #1</p>	

SOLEN MURA 5B - BRACE



*THE DIMENSIONS TAKE INTO ACCOUNT THE DADOS ON THE SIDE PANELS. THE WIDTH WILL HAVE TO BE ADJUSTED IF YOU DO NOT MAKE THE DADOS.

<p>Legal Owner:</p>  <p>SOLEN ÉLECTRONIQUE INC., 3940 BLVD. SIR-WILFRID-LAURIER, (450) 656-2759 solen@solen.ca</p>	<p>Description:</p> <p>SOLEN MURA 5B v2 - BRACE</p>	<p>Projection Method:</p> <p>THIRD ANGLE </p>
	<p>Drawing Scale: 1:5</p>	<p>All Dimensions: mm [in]</p>
	<p>Material: 1/2" MDF</p>	
	<p>Drawn by:</p> <p>LAURENT TARDIF</p>	
	<p>Drawn Date:</p> <p>2026-03-23</p>	<p>Sheet Size:</p> <p>LETTER</p>
<p>Sheet: 11 of 16</p>	<p>Revision: #1</p>	

SOLEN MURA 5B - LEFT SIDE

D

C

B

A

D

C

B

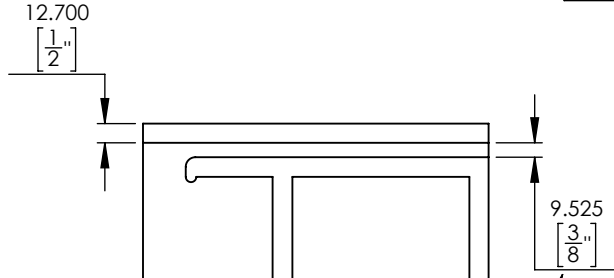
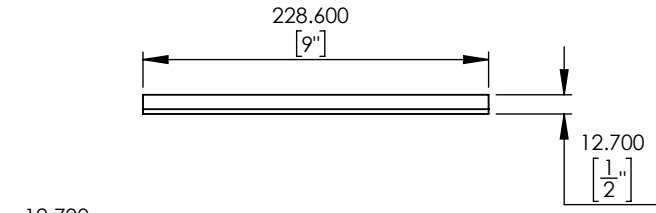

A

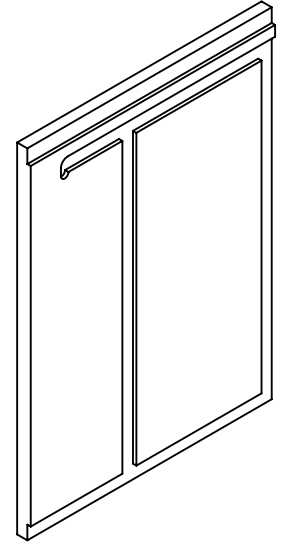
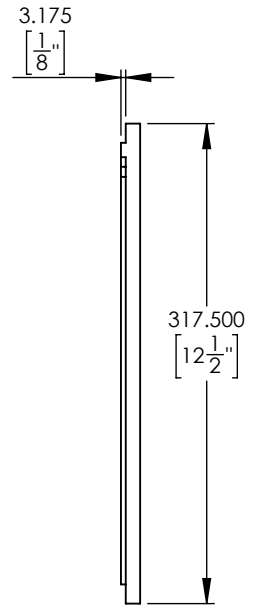

HEIGHT OF PORT

DISTANCE FROM THE FRONT OF THE BRACE TO THE INSIDE OF THE BAFFLE



 SOLEN ÉLECTRONIQUE INC., 3940 BLVD. SIR-WILFRID-LAURIER, (450) 656-2759 solen@solen.ca	Legal Owner: SOLEN MURA 5B v2 - LEFT SIDE	Description: SOLEN MURA 5B v2 - LEFT SIDE	Projection Method: THIRD ANGLE 
	This drawing and any information or descriptive material set out on it are the confidential and copyright property of Solen Électronique INC. and MUST NOT BE DISCLOSED, COPIED, LOANED in whole or part or used for any purpose without the written permission of Solen Électronique INC.		Drawing Scale: 1:5 All Dimensions: mm [in]
			Material: 1/2" MDF
			Drawn by: LAURENT TARDIF
	Drawn Date: 2026-03-23	Sheet Size: LETTER	
Sheet: 12 of 16	Revision: #1		

6

5

4

3

2

1

6

5

4

3



2

1

SOLEN MURA 5B - RIGHT SIDE

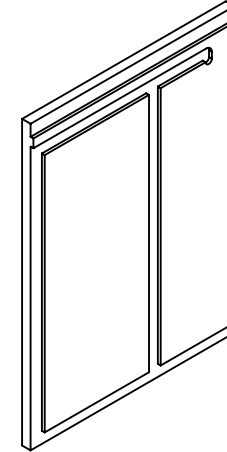
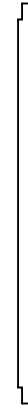
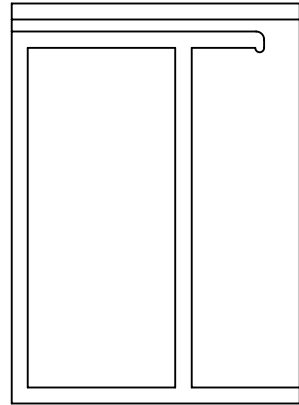
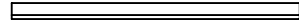
SAME AS LEFT SIDE, BUT MIRRORED



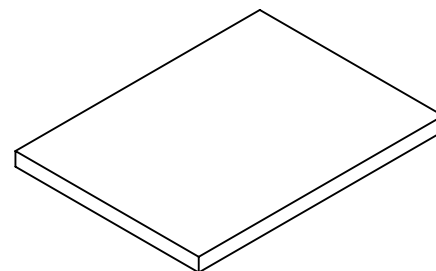
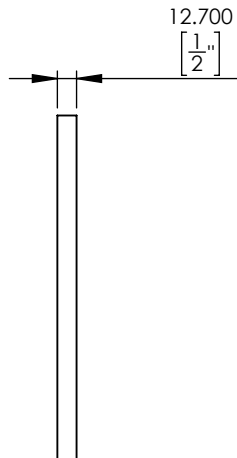
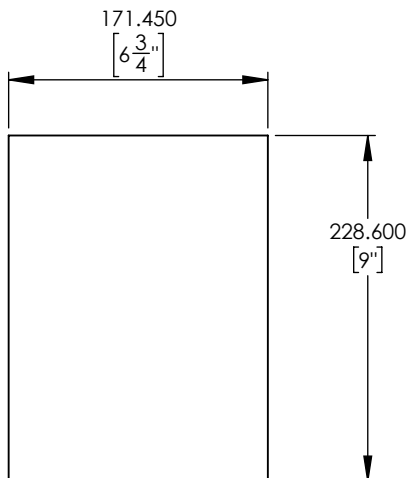

Legal Owner:  SOLEN ÉLECTRONIQUE INC., 3940 BLVD. SIR-WILFRID-LAURIER, (450) 656-2759 solen@solen.ca	Description: SOLEN MURA 5B v2 - RIGHT SIDE	Projection Method: THIRD ANGLE 	
	This drawing and any information or descriptive material set out on it are the confidential and copyright property of Solen Électronique INC. and MUST NOT BE DISCLOSED, COPIED, LOANED in whole or part or used for any purpose without the written permission of Solen Électronique INC.	Drawing Scale: 1:6	All Dimensions: mm [in]
	Material: 1/2" MDF	Drawn by: LAURENT TARDIF	
	Drawn Date: 2026-03-23	Sheet Size: LETTER	
	Sheet: 13 of 16	Revision: #1	

SOLEN MURA 5B - TOP&BOTTOM



*THE DIMENSIONS TAKE INTO ACCOUNT THE DADOS ON THE SIDE PANELS.
THE WIDTH WILL HAVE TO BE ADJUSTED IF YOU DO NOT MAKE THE DADOS.

 SOLEN ÉLECTRONIQUE INC., 3940 BLVD. SIR-WILFRID-LAURIER, (450) 656-2759 solen@solen.ca	Legal Owner: SOLENELECTRONIQUE INC.	Description: SOLENELECTRONIQUE MURA 5B v2 - TOP&BOTTOM	Projection Method: THIRD ANGLE 
			Drawing Scale: 1:5 All Dimensions: mm [in]
			Material: 1/2" MDF
			Drawn by: LAURENT TARDIF
			Drawn Date: 2026-03-23
		Sheet: 14 of 16	Revision: #1

SOLEN MURA 5B - PORT

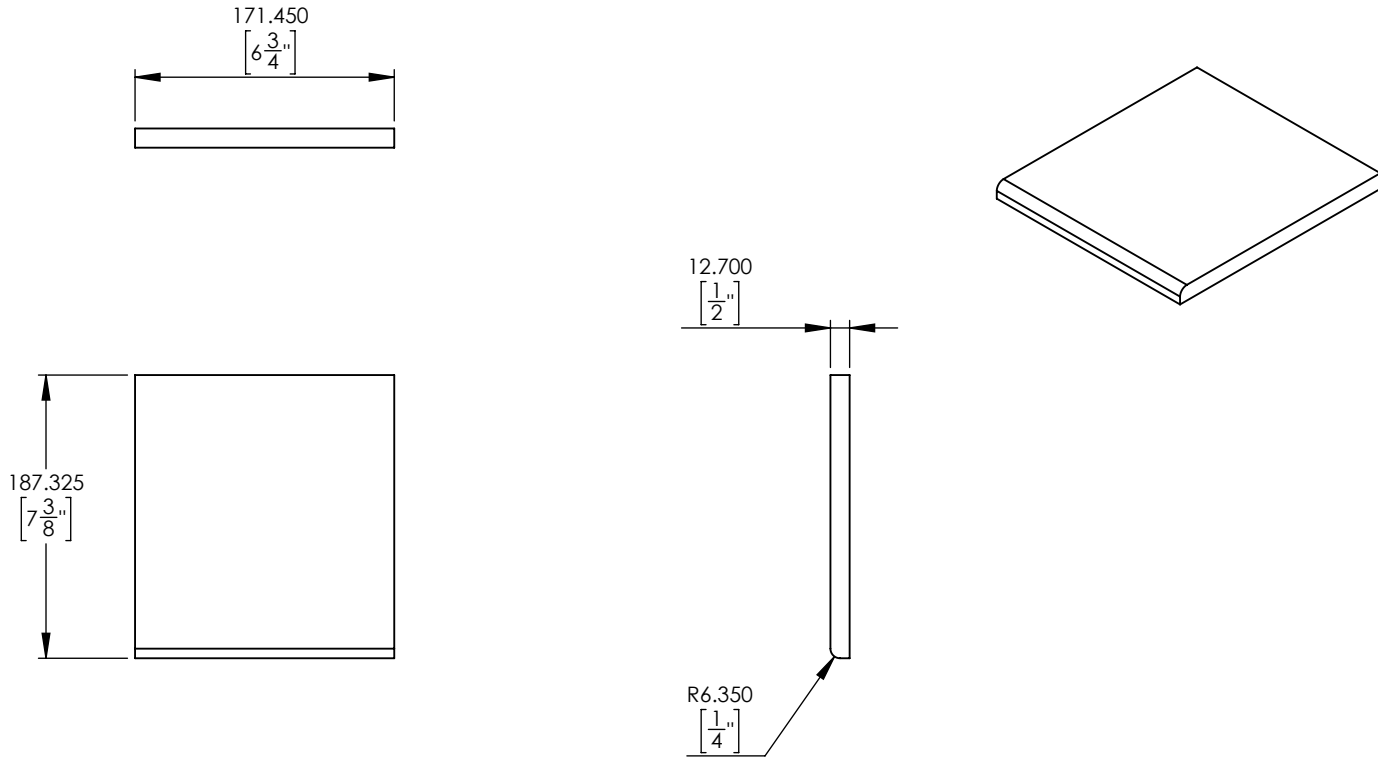

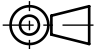

*THE DIMENSIONS TAKE INTO ACCOUNT THE DADOS ON THE SIDE PANELS.
THE WIDTH WILL HAVE TO BE ADJUSTED IF YOU DO NOT MAKE THE DADOS.

<p>Legal Owner:</p>  <p>SOLEN ÉLECTRONIQUE INC. 3940 BLVD. SIR-WILFRID-LAURIER, (450) 656-2759 solen@solen.ca</p>	<p>Description:</p> <p>SOLEN MURA 5B v2 - PORT</p>	<p>Projection Method:</p> <p>THIRD ANGLE </p>
	<p>Material:</p> <p>1/2" MDF</p>	<p>Drawing Scale: 1:5</p>
	<p>Drawn by:</p> <p>LAURENT TARDIF</p>	<p>All Dimensions:</p> <p>mm [in]</p>
	<p>Drawn Date:</p> <p>2026-03-23</p>	<p>Sheet Size:</p> <p>LETTER</p>
	<p>Sheet: 15 of 16</p>	<p>Revision: #1</p>

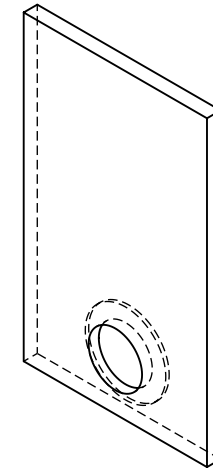
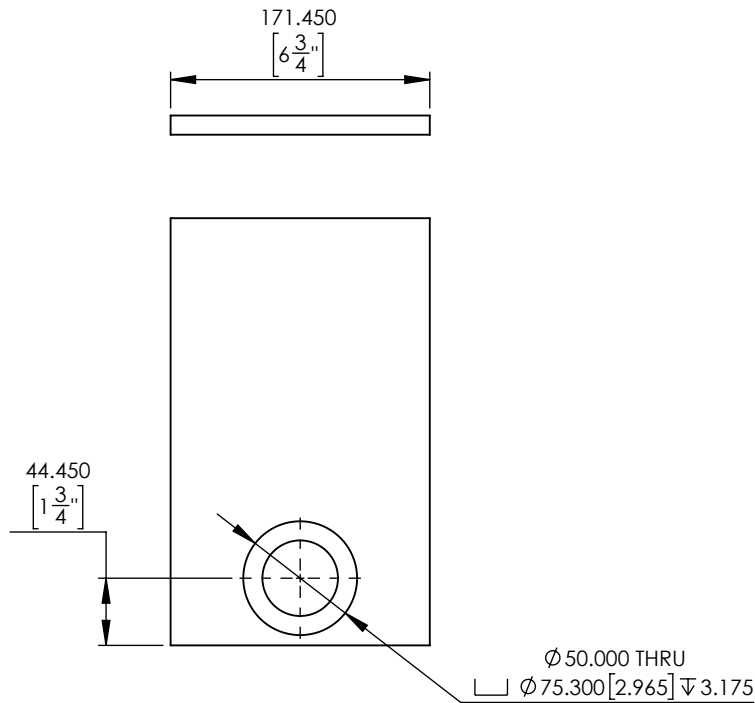
SOLEN MURA 5B - BACK



*THE DIMENSIONS TAKE INTO ACCOUNT THE DADOS ON THE SIDE PANELS.
THE WIDTH WILL HAVE TO BE ADJUSTED IF YOU DO NOT MAKE THE DADOS.

 SOLEN ÉLECTRONIQUE INC., 3940 BLVD. SIR-WILFRID-LAURIER, (450) 656-2759 solen@solen.ca	Legal Owner: SOLENELECTRONIQUE INC.	Description: SOLENELECTRONIQUE MURA 5B v2 - BACK	Projection Method: THIRD ANGLE 
			Drawing Scale: 1:5 All Dimensions: mm [in]
			Material: 1/2" MDF
			Drawn by: LAURENT TARDIF
	Drawn Date: 2026-03-23	Sheet Size: LETTER	
Sheet: 16 of 16		Revision: #1	