



## Features

The dynamical cone geometry built with Magnesium composite materials creates an authentic sound. The hand coated dustcap plus the airflow optimized motor design supports the balanced and detailed sound impression.

Die dynamische Membran-Geometrie in Magnesium-Composite-Ausführung erzeugt eine authentische Klangwiedergabe. Die handgestrichene Kalotte, kombiniert mit einem strömungsoptimierten Antrieb, unterstützt zusätzlich das ausgewogen konturreiche Klangbild.

#1.1068.04

## Main technical data

Nominal impedance	$Z_n$	8	$\Omega$
DC resistance	$R_e$	5.8	$\Omega$
Resonance frequency 1W	$f_r$	56	Hz
Resonance frequency TSP	$f_r$	58	Hz
Suspension compliance	$C_{MS}$	1.78	mm/N
Mechanical Q	$Q_{ms}$	6.37	
Electrical Q	$Q_{es}$	0.48	
Total Q	$Q_{ts}$	0.44	
Mechanical resistance	$R_{MS}$	0.25	kg/s

Total moving mass (incl. air mass)	$M_{MD}$	4.3	g
Effective piston area	$S_D$	50	cm <sup>2</sup>
Voice coil inductance	$L_e$	0.35	mH
Force factor	$B_L \cdot x_l$	4.2	Tm
Xmax electrical	+/-	4.0	mm
Xmax mechanical	+/-	8.2	mm
Equivalent air vol. of suspension	$V_{AS}$	6.2	dm <sup>3</sup>
Characteristic SPL 1 Watt/1m		87	dB SPL
Rated power		50	W

## Frequency response

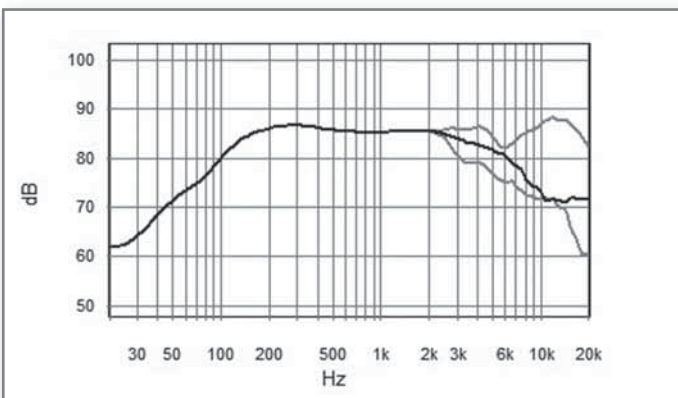

SPL 2,83 V/1m; black 30°, grey 0,60°  
Half space; endless baffle; enclosure 700 l

## Impedance

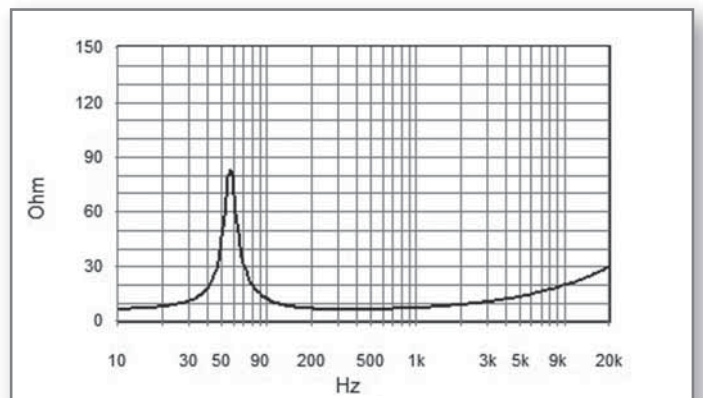

Measured free air without baffle

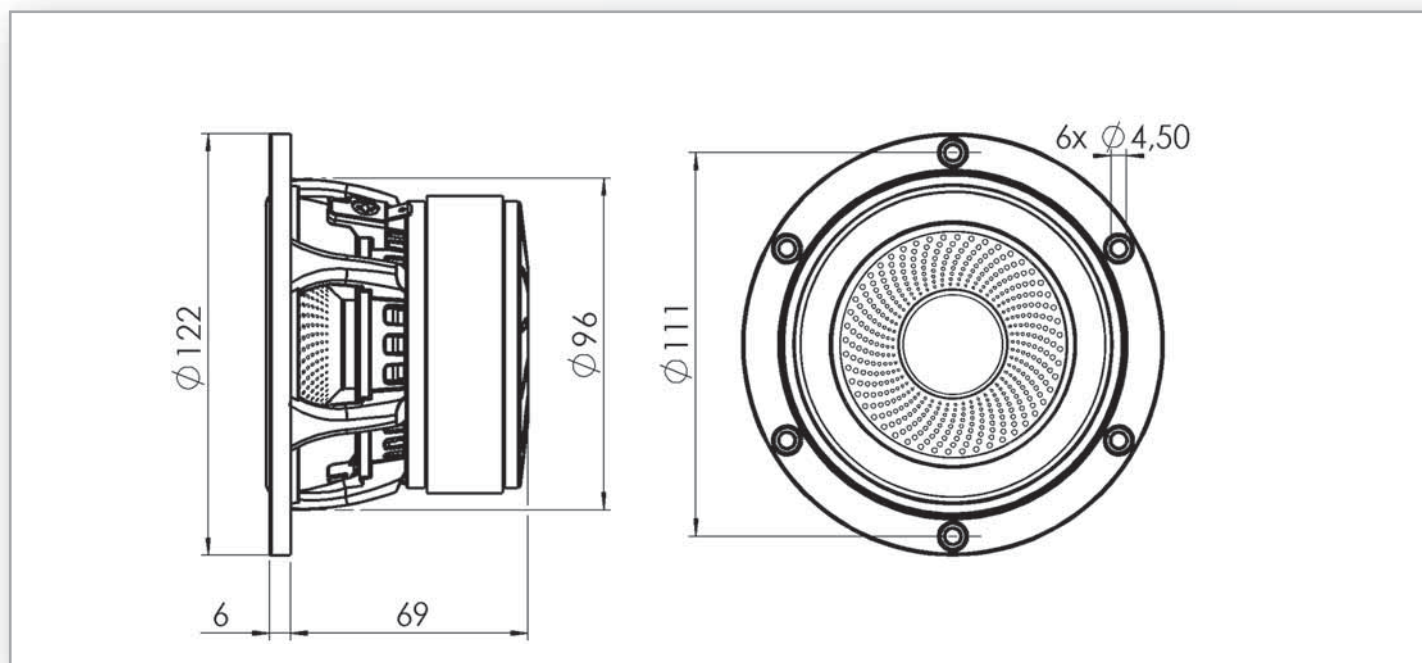

### Mechanical data

Overall diameter	122	mm
Cutout diameter	96	mm
Frame depth	6	mm
Overall depth	75	mm
Screw holes diameter	4.5/ 8	mm
Terminal	4.8/ 6.3	mm
Weight	1.28	kg

### Voice coil

Diameter	25	mm
Height	13	mm
Wire material	Cu	
Former material	Glass fibre	
Layers	2	

### Magnet

Flux density	1.11	T
Height of gap	5	mm
Material	Ferrite	
Dimension	86 x 32	mm
Height	22	mm
Motor type	Overhung	
Ferrofluid	no	

### Other data

Recommended frequency range	70-20000Hz
-----------------------------	------------