

**Features**

- 15" Kevlar impregnated paper cone
- Dual voice coils for added versatility
- High power handling
- Long excursion design
- Heavy magnet structure with vented pole piece
- Made in the USA

**Parameters**

Impedance ( $\Omega$ )	8
Re ( $\Omega$ )	2.8
Le (mH) @ 1 kHz	1.82
Fs (Hz)	18.8
Qms	8.66
Qes	0.38
Qts	0.36
Mms (g)	297.1
Cms (mm/N)	0.24
Sd (cm <sup>2</sup> )	829.6
Vd (liters)	1252.7
BL (Tm)	16.00
VAS (liters)	232.2
XMAX (mm)	15.1
VC Diameter (mm)	51
SPL (dB@1W/1m)	90.0
RMS Power Handling (w)	350
Usable Frequency Range (Hz)	20 - 450

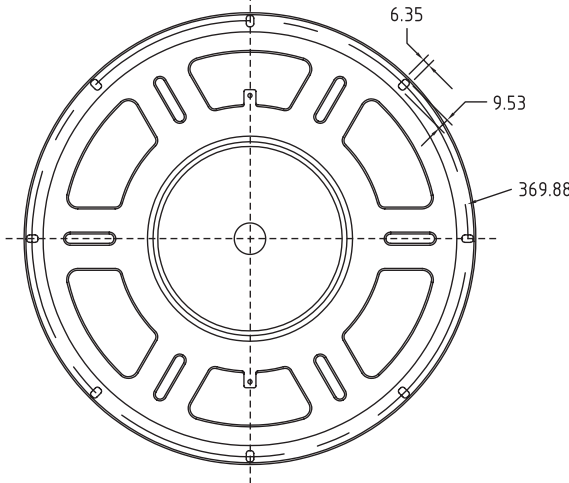
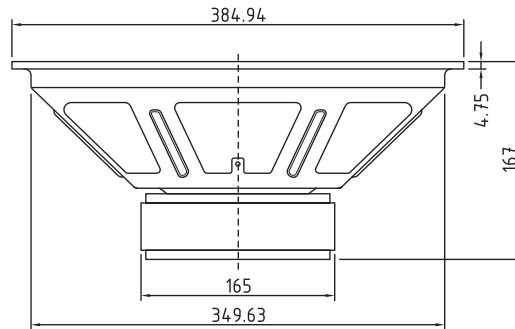

Note: All dimensions in mm.

**Frequency Response**

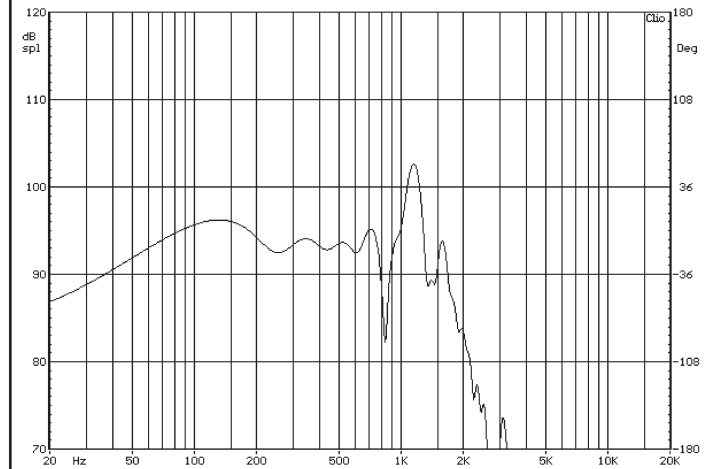

Note: Due to testing limitations, response below 200 Hz is not an actual representation.

**Impedance/Phase**

