

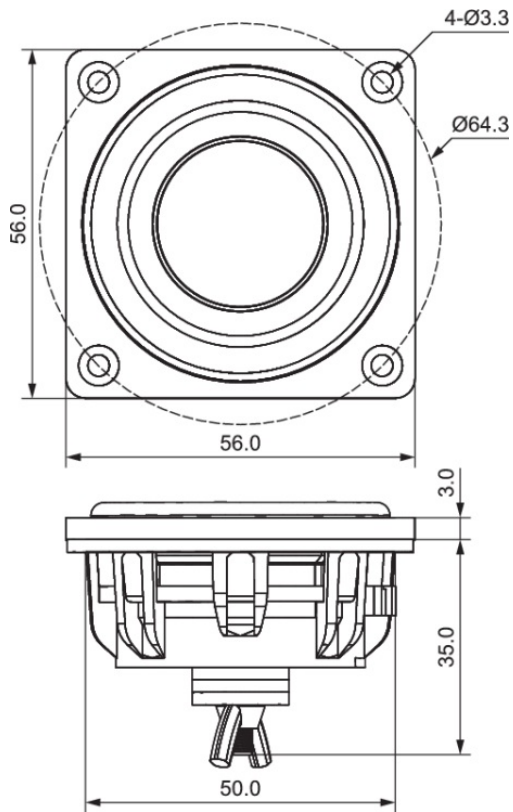

DMA58-PR 2" DMA Series Passive Radiator



FEATURES

- Perfect match for the Dayton Audio DMA series drivers
- Allows tuning small enclosures lower than possible using conventional ports
- Rear mounted threaded post allows easy mass adjustment for custom tuning
- DIY friendly, oversized mounting flange makes installation simple

PARAMETERS

Fs	39.8 Hz
Qms	3.93
Mms	6.7 g
Cms	2.4 mm/N
Sd	14.5 cm ²
Vd	0.010 liters
Vas	0.71 liters
Xmax	7 mm
Rms	0.43 kg/s

Note: Parameters above are for the passive only with no additional mass added.