

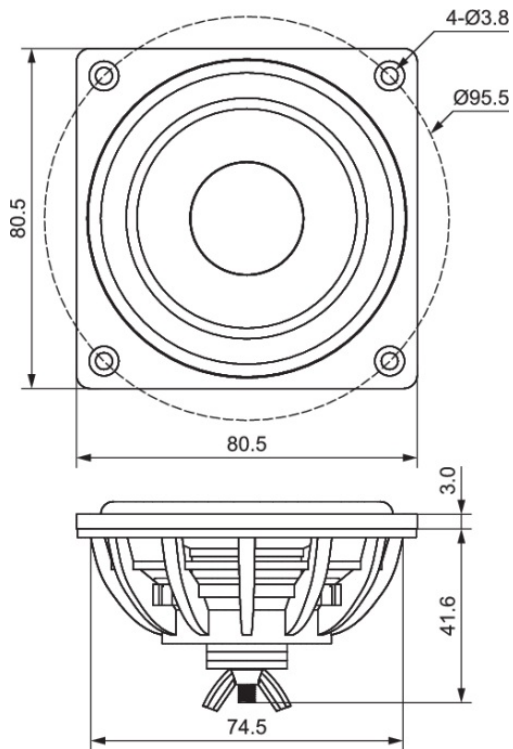

DMA80-PR 3" DMA Series Passive Radiator



FEATURES

- Perfect match for the Dayton Audio DMA series drivers
- Allows tuning small enclosures lower than possible using conventional ports
- Rear mounted threaded post allows easy mass adjustment for custom tuning
- DIY friendly, oversized mounting flange makes installation simple

PARAMETERS

Fs	34.6 Hz
Qms	8.91
Mms	13.7 g
Cms	1.41 mm/N
Sd	31.2 cm ²
Vd	0.02 liters
Vas	2.14 liters
Xmax	7 mm
Rms	0.33 kg/s

Note: Parameters above are for the passive only with no additional mass added.