

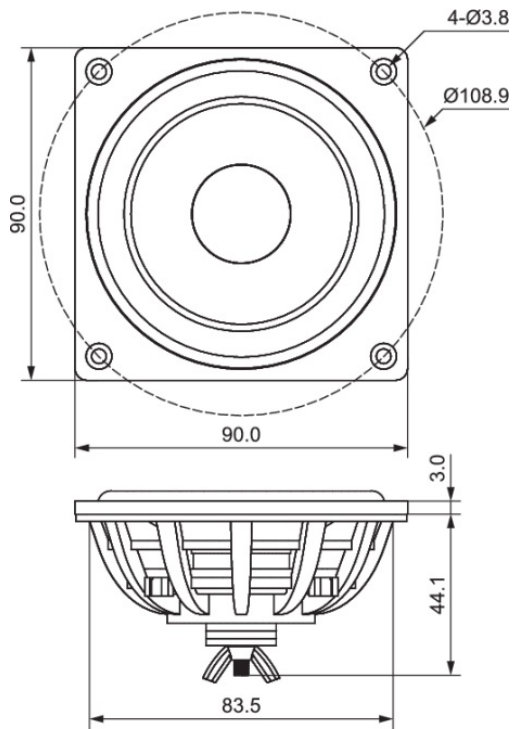

DMA90-PR 3-1/2" DMA Series Passive Radiator



FEATURES

- Perfect match for the Dayton Audio DMA series drivers
- Allows tuning small enclosures lower than possible using conventional ports
- Rear mounted threaded post allows easy mass adjustment for custom tuning
- DIY friendly, oversized mounting flange makes installation simple

PARAMETERS

Fs	38.0 Hz
Qms	5.01
Mms	15.9 g
Cms	1.10 mm/N
Sd	38.5 cm ²
Vd	0.03 liters
Vas	2.3 liters
Xmax	8 mm
Rms	0.76 kg/s

Note: Parameters above are for the passive only with no additional mass added.