



## Box Properties

### --Description--

Name:

Type: Vented Box

Shape: Prism, square (optimum)

### --Box Parameters--

Vb = 6 cu.ft

V(total) = 6.484 cu.ft

Fb = 36.01 Hz

QL = 7

F3 = 36.78 Hz

Fill = minimal

### --Vents--

No. of Vents = 1

Vent shape = rectangle

Vent ends = one flush

Hv = 17.9 in

Wv = 2.5 in

Lv = 11.5 in

## Driver Properties

### --Description--

Name: RV3143

Type: Standard one-way driver

Company: Volt Loudspeakers, Ltd.

Frame: Painted die cast aluminum

Voice Coil: 75 mm, copper

Terminals: Metal push

Magnet: Centered pole system, 5 kg

### --Configuration--

**No. of Drivers = 2**

Mounting = Standard

Wiring = Parallel

Drivers sum coherently = Yes

### --Mechanical Parameters--

Fs = 35 Hz

Qms = 5.35

Vas = 86 liters [172]

Cms = 0.264 mm/N [0.132]

Mms = 76 g [152]

Rms = 3.22 kg/s [6.44]

Xmax = 5.2 mm

Xmech = 7.8 mm

P-Dia = 247 mm [349.3]

Sd = 479 sq.cm [958]

P-Vd = 0.25 liters [0.5]

### --Electrical Parameters--

Qes = 0.32

Re = 6.1 ohms [3.05]

Le = 3.2 mH [1.6]

Z = 8 ohms [4]

BL = 18 Tm [17.85]

Pe = 300 watts [600]

### --Electromech. Parameters--

Qts = 0.3

no = 1.111 % [2.222]

1-W SPL = 91.5 dB [94.51]

2.83-V SPL = 93.7 dB [99.72]



### Wiring Diagram

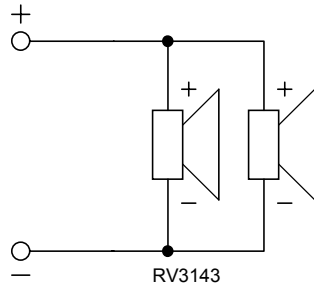

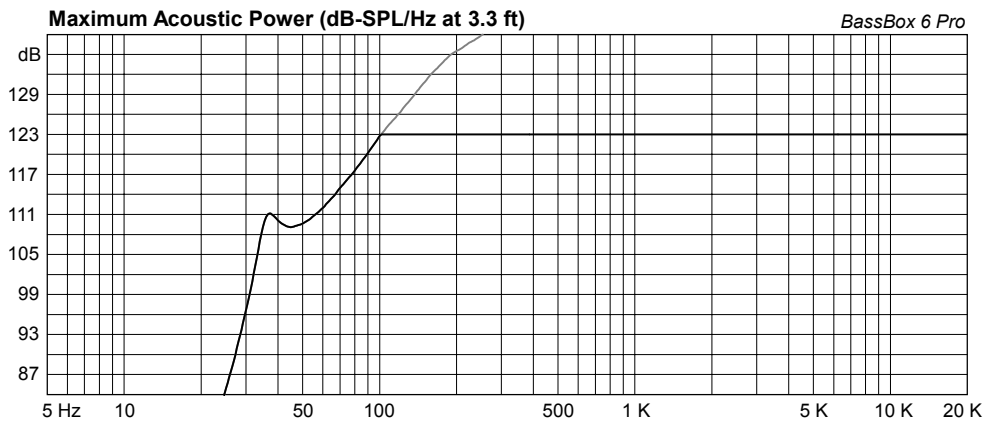
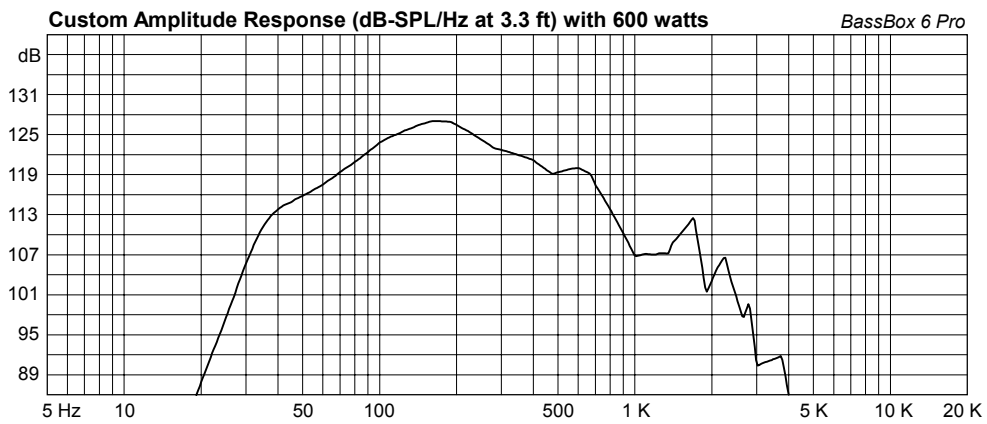

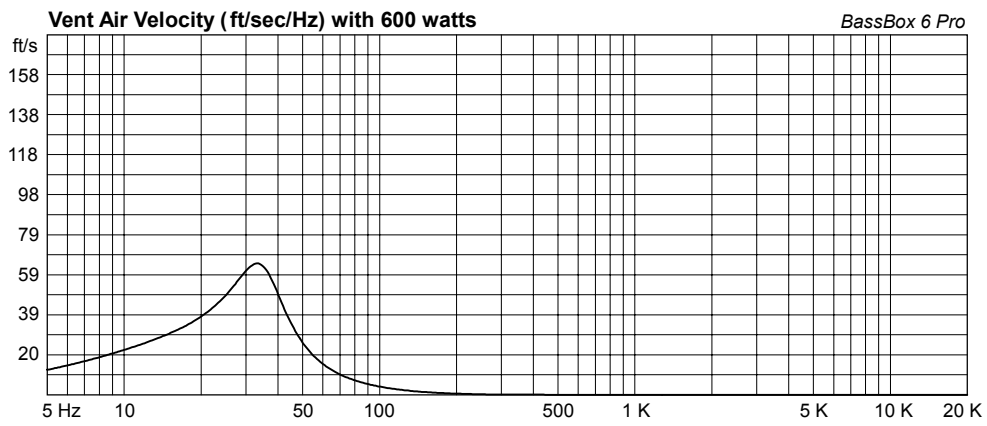
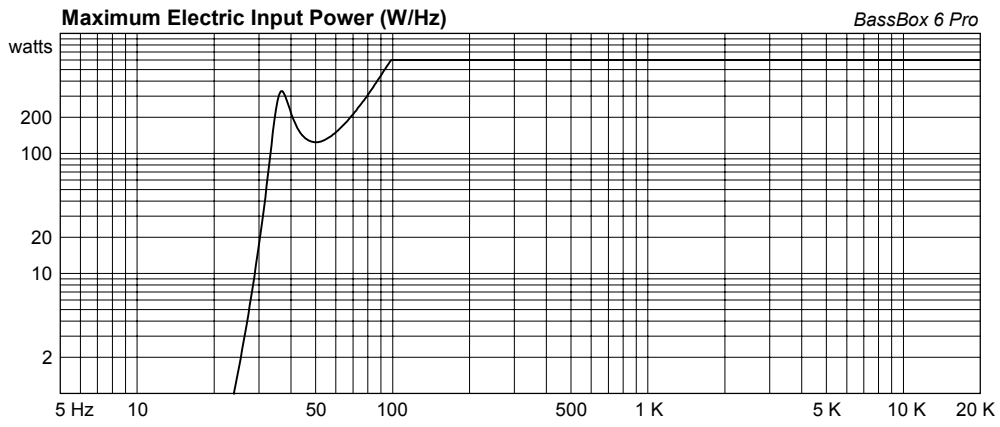

# Custom Three-Way Crossover Network Design

By Chris, Solen Inc.

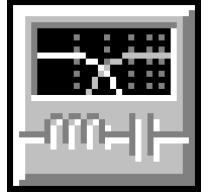

## 3-Way Crossover Network

Low-Pass (LP) Filter: 1 required

Type: 2nd-Order All-Pass (APC)

Desired Corner Frequency: 750 Hz

Band-Pass (BP) Filter: 1 required

Type: 2nd-Order All-Pass (APC)

Desired Lower Corner Freq: 750 Hz

Desired Upper Corner Freq: 3800 Hz

High-Pass (HP) Filter: 1 required

Type: 2nd-Order All-Pass (APC)

Desired Corner Frequency: 3800 Hz

C1 = 5.6  $\mu$ F, Film & Foil SA560, 0.00671 ohms

C2 = 22  $\mu$ F, Film & Foil SA2200BN, 0.0033 ohms

C3 = 2.2  $\mu$ F, Polypropylene, 0.0129 ohms

C4 = 33  $\mu$ F, Polypropylene, 0.00288 ohms

L1 = 0.36 mH, Litz (#16), 0.291 ohms

L2 = 3.6 mH, Air Core (#16), 0.664 ohms

L3 = 0.47 mH, Litz (#16), 0.304 ohms

L4 = 1.3 mH, Air Core (#14), 0.24 ohms

R1 = 3.75 ohms

## Tweeter

### 2.36 dB L-Pad

Rp1 = 1 ohms

Rp2 = 16 ohms

## Midrange

### Impedance EQ

Req = 7.5 ohms

Ce = 9.1  $\mu$ F

## Woofers

### Impedance EQ

Req = 3.9 ohms

Ce = 150  $\mu$ F

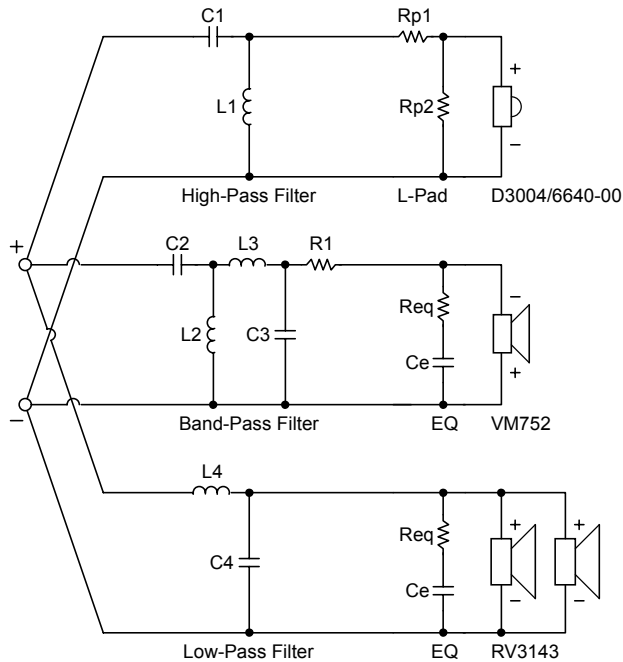



### Tweeter Properties

--Driver Description--

Name: D3004/6640-00

Type: Standard one-way driver

Company: Scan-Speak A/S

--Driver Configuration--

**No. of Drivers = 1**

--Driver Parameters--

Fs = 500 Hz  
 Qms = 3.536  
 Vas = 0.0202 liters  
 Cms = 0.29 mm/N  
 Mms = 0.35 g  
 Rms = 0.31 kg/s  
 Xmax = 0.2 mm  
 Xmech = 0.3 mm  
 Sd = 7 sq.cm  
 P-Vd = 0.00014 liters  
 Qes = 0.624  
 Re = 3 ohms  
 Le = 0.03 mH  
 Z = 4 ohms  
 BL = 2.3 Tm  
 Pe = 150 watts  
 Qts = 0.53  
 no = 0.39 %  
 1-W SPL = 87.24 dB  
 2.83-V SPL = 91.5 dB

### Midrange Properties

--Driver Description--

Name: VM752

Type: One-way sealed back driver

Company: Volt Loudspeakers, Ltd.

Ferrofluid included

--Driver Configuration--

**No. of Drivers = 1**

--Driver Parameters--

Fs = 400 Hz  
 Qms = 9.53  
 Vas = 0.16 liters  
 Cms = 0.04 mm/N  
 Mms = 4 g  
 Rms = 1.04 kg/s  
 Xmax = 1 mm  
 Xmech = 1.5 mm  
 P-Dia = 75 mm  
 Sd = 57 sq.cm  
 P-Vd = 0.005 liters  
 Qes = 0.81  
 Re = 6.3 ohms  
 Le = 0.37 mH  
 Z = 8 ohms  
 BL = 8.843 Tm  
 Pe = 100 watts  
 Qts = 0.75  
 no = 1.22 %  
 1-W SPL = 94 dB  
 2.83-V SPL = 94 dB

### Woofers Properties

--Driver Description--

Name: RV3143

Type: Standard one-way driver

Company: Volt Loudspeakers, Ltd.

Frame: Painted die cast aluminum

Voice Coil: 75 mm, copper

Terminals: Metal push

Magnet: Centered pole system, 5 kg

--Driver Configuration--

**No. of Drivers = 2**

Mounting = Standard

Wiring = Parallel

--Driver Parameters--

Fs = 35 Hz  
 Qms = 5.35  
 Vas = 86 liters [172]  
 Cms = 0.264 mm/N [0.132]  
 Mms = 76 g [152]  
 Rms = 3.22 kg/s [6.44]  
 Xmax = 5.2 mm  
 Xmech = 7.8 mm  
 P-Dia = 247 mm [349.3]  
 Sd = 479 sq.cm [958]  
 P-Vd = 0.25 liters [0.5]  
 Qes = 0.32  
 Re = 6.1 ohms [3.05]  
 Le = 3.2 mH [1.6]  
 Z = 8 ohms [4]  
 BL = 18 Tm [17.85]  
 Pe = 300 watts [600]  
 Qts = 0.3  
 no = 1.111 % [2.222]  
 1-W SPL = 91.5 dB [94.51]  
 2.83-V SPL = 93.7 dB [99.72]

Graph Key: — LP — BP — HP — Net

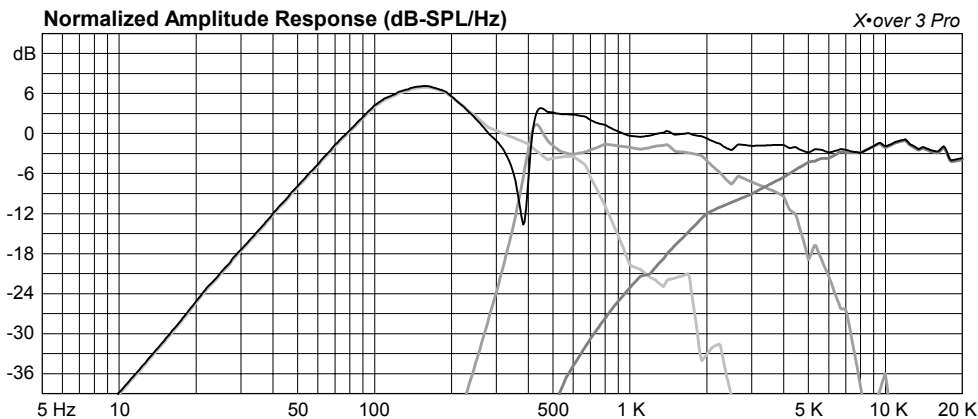

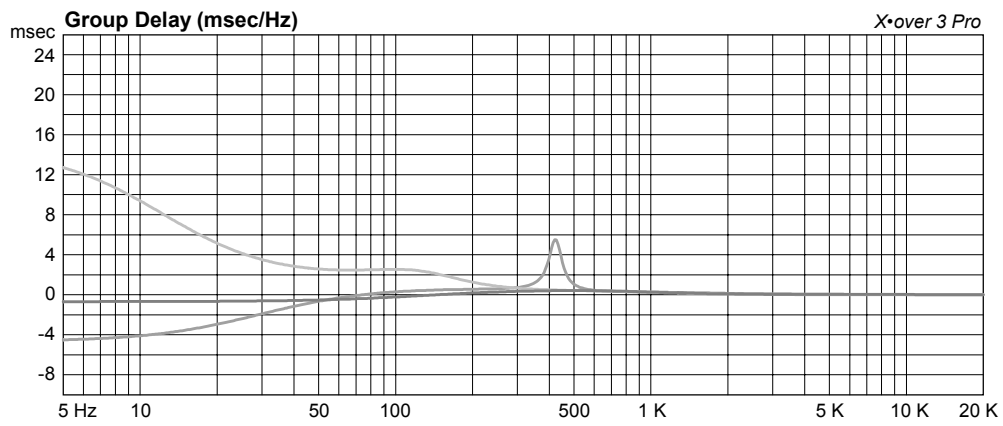
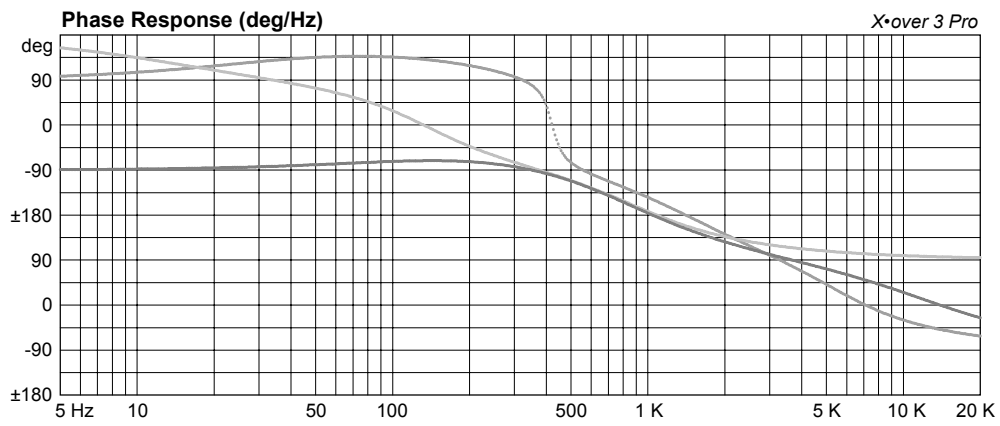
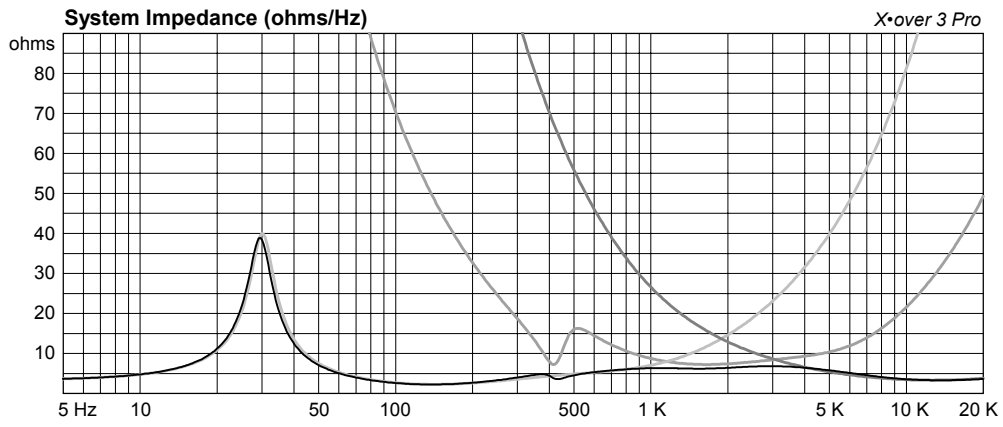

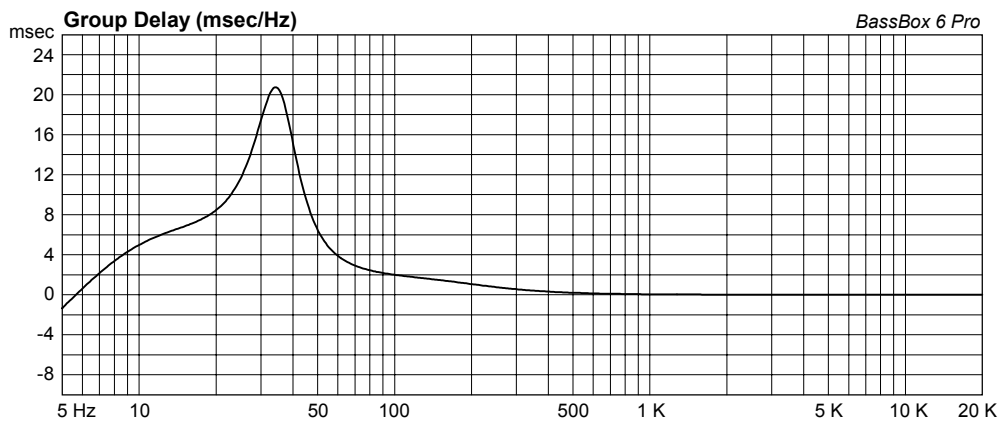
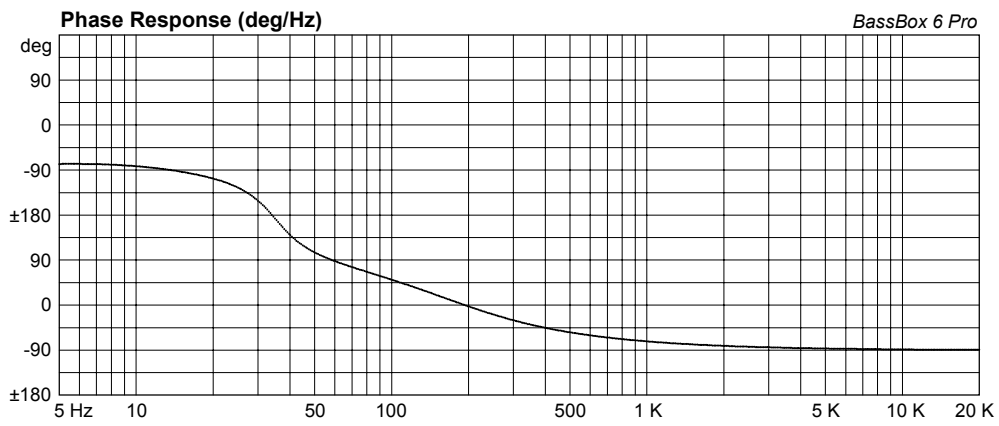
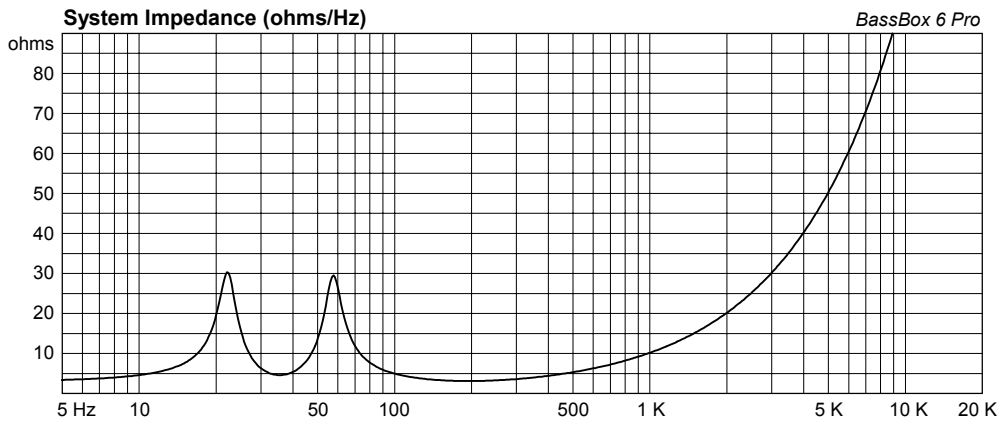



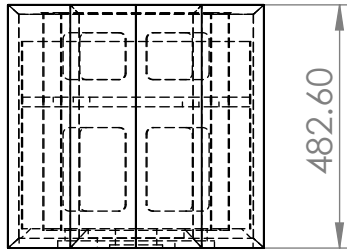

ITEM NO.	PART NUMBER	DESCRIPTION	QTY.
1	Front		1
2	Back		1
3	Bottom		1
4	Top		1
5	Top		1
6	Side		2
7	Vertical Brace		1
8	Horizontal Brace - 01		1
9	Horizontal Brace - 02		1
10	Port - 01		1

