

20W/40W PA MIXER-AMPLIFIER 70V/100V

Model: DA20T/DA40T User Manual

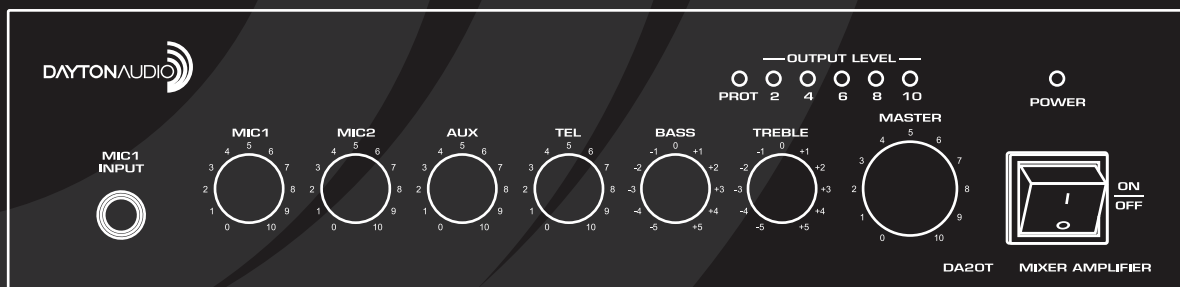

TABLE OF CONTENTS

1. SAFETY PRECAUTIONS	3
2. GENERAL DESCRIPTION	5
3. FEATURES AND FUNCTIONS	
3.1 Front Panel	6
3.2 Rear Panel.....	6
4. CONNECTIONS	
4.1 Speaker Connections	7
5. OPERATION	7
6. APPLICATIONS	8
7. APPLICATION DIAGRAM	9
8.SPECIFICATIONS	10
9.DIMENSIONAL DIAGRAM	11

1.SAFETY PRECAUTIONS

- Be sure to carefully read all the safety instructions in this manual before use.
- Be sure to follow all safety instructions in this manual.
- Please keep this instruction manual for future reference.

Safety Warning and Cautions

Safety Cautions and Warnings are used in this manual to prevent bodily injury and property damage. Before operating this product please read and follow all safety precautions to avoid potential safety risks.



WARNING

Indicates a potentially hazardous situation which could result in serious personal injury or death.



CAUTION

Indicates a potentially hazardous situation which could result in minor or major personal injury or property damage.



WARNING

When Installing the Unit

- Do not expose this product to rain or an environment where it could be splashed by water or other liquids.
- Only use this product with the voltage specified. Using higher voltage may result in fire or electric shock.
- Do not cut, kink, damage or modify the power cord. Avoid using the power cord in close proximity to heaters, and never place heavy objects on the cord. This could result in electric shock or fire.
- Be sure to replace the speaker terminal cover after the connections are complete. High voltage is applied to the speaker terminals. To avoid electric shock, never touch these terminals.
- Be sure you ground the amplifier using the safety ground (earth) terminal to avoid electric shock. Never ground this product to a gas pipe or other flammable items.
- Avoid installing or mounting this product on an unstable or slanted surface. Doing so may cause the unit to fall, resulting in personal injury or property damage.

When the Unit is in Use

- Should any of the following issues occur during use, immediately switch off the power and disconnect the power cord from the AC outlet. Make no further attempt to operate the malfunctioning product, doing so may cause fire or electric shock. Contact your Dayton Audio dealer for service and repair.
 1. If you detect smoke or a strange smell coming from the unit.
 2. If any liquid or metal gets inside the product.
 3. If the product is dropped or falls and case is broken.
 4. If the power cord is cut or damaged.
 5. If the sound becomes distorted.
- To prevent a fire or electric shock, never open or remove the product cover; there are high voltage components inside. Refer all servicing and repair to your nearest Dayton Audio dealer.
- Do not place cups, bowls, or anything containing liquid or metal objects on top of the product.
- To prevent fire or electric shock, do not insert metal objects or flammable materials in the cover or vents of this product.

CAUTION

When Installing the Unit

- Never plug in or remove the power cord with wet hands, doing so may cause electric shock.
- When unplugging the power cord, be sure to grasp the power cord plug; never pull on the cord itself. Operating the unit with a damaged power cord may cause a fire or electric shock.
- When moving the unit, be sure to remove the power cord from the wall outlet. Moving the unit with the power cord connected to the outlet may cause damage to the power cord or cause you to accidentally drop the product, resulting in personal or property damage.
- Do not block the ventilation areas in the cover. Doing so may cause heat to build up inside the unit, resulting in product failure and possibly fire.
- Avoid installing the unit in humid or dusty locations, direct sunlight, near heaters or in locations generating sooty smoke/steam.
- Do not place heavy objects on top of the product. This can result in the product or object to fall, causing personal injury or property damage.
- Before powering on the product make sure that the master volume control is set to the lowest setting. Loud or high volume noise can damage or impair hearing.
- Do not operate the unit if the sound is distorting. This is an indication of a product malfunction, immediately unplug the power and contact your Dayton Audio dealer for service or repair.
- Dust allowed to accumulate inside the product could result in fire or electrical damage. Be sure to consult your Dayton Audio dealer for cleaning service and repair. Periodically clean dust buildup from the power cord plug and wall outlet to avoid electrical fire. Ensure the power cord plug is securely inserted in the wall outlet.
- For safety when cleaning or leaving the unit unattended for long periods of time, switch the power off, unplug the power cord plug from the wall outlet. Doing otherwise may cause a fire or electric shock.

An all-pole mains switch with a contact separation of at least 3 mm in each pole shall be incorporated in the electrical installation of the building.

2. FEATURES

1. Rated Power: 60W/120W.
2. 100V, 70V constant voltage outputs and 4~16 ohms constant resistance output.
3. Commercial grade toroidal transformers produce high performance audio on a wide range of frequencies with minimum noise and high fidelity even at high volume.
4. Protection against overload, short circuit and power fluctuation for optimum reliability.
5. VOX feature mutes AUX inputs when input is detected on MIC 1. Time fade adjustment control allows resumption of music to be quick or gradual.
6. Phantom power available on MIC 1 input for condenser type microphones.
7. TEL priority: TEL input will override AUX 1-2 and MIC 1-2.

3. FEATURES AND FUNCTIONS

3.1 FRONT PANEL

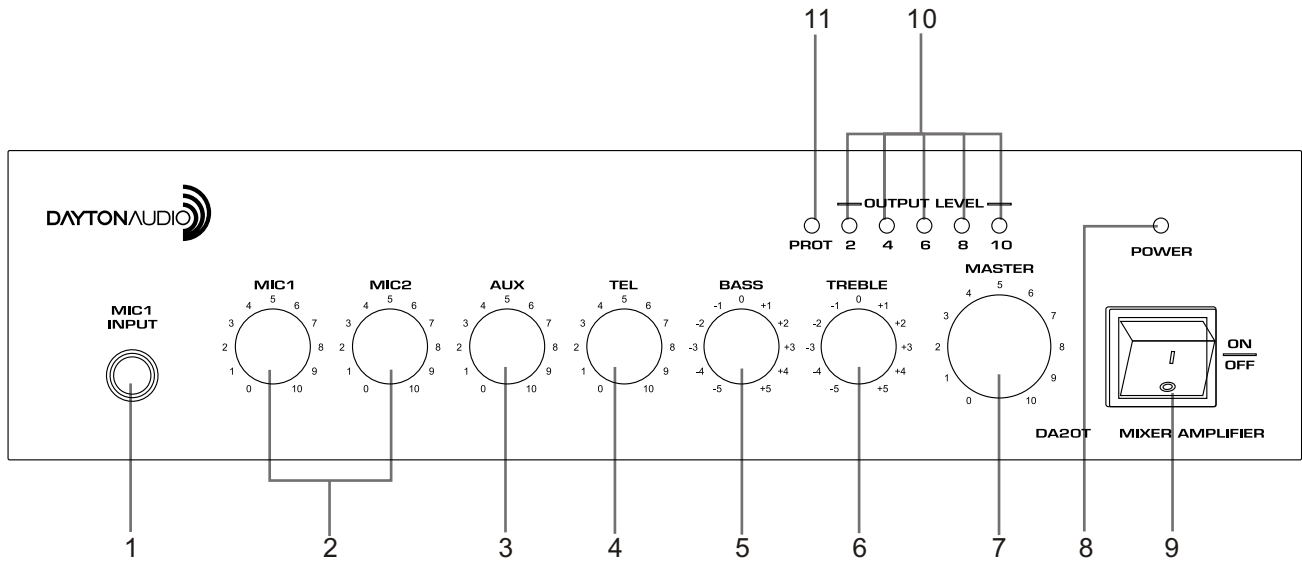

1. MIC1 INPUT

MIC1 1/4" phone jack input

2. MIC1/MIC2

MIC volume controls (MIC1/MIC2)

3. AUX1/AUX2

Volume control AUX

4. TEL

Volume control TEL

5. BASS

Bass response adjustment. Rotate clockwise to increase bass output and counterclockwise to reduce it.

6. TREBLE

Treble response adjustment. Rotate clockwise to increase treble output and counterclockwise to reduce it.

7. MASTER

Master volume control

8. POWER

Power indicator

9. POWER SWITCH

ON/OFF toggle switch

10. LEVEL INDICATORS

Signal output level indicators

11. PROT

Protection mode status indicator.

This indicator will illuminate if the product is in protection mode due to overheating or overload.

FEATURES AND FUNCTIONS

3.2 REAR PANEL

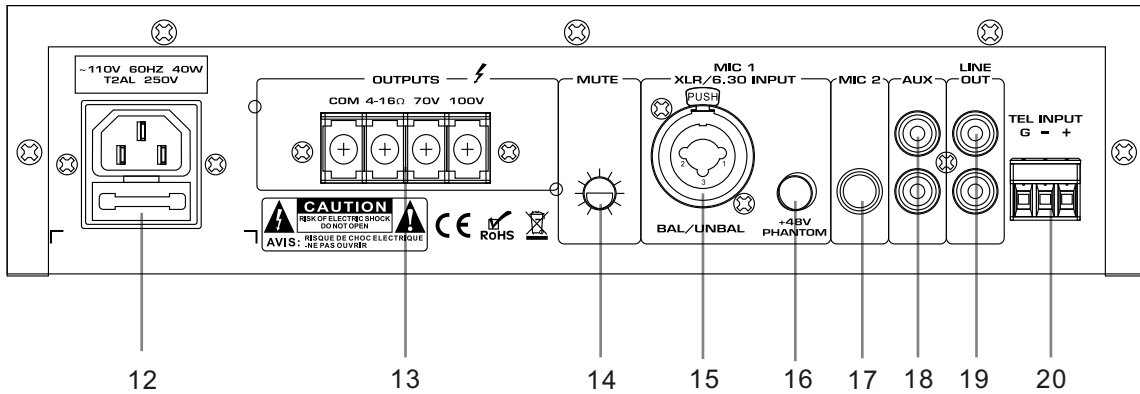

- 12. ~110V 60Hz POWER INPUT
- 13. SPEAKER TERMINALS
Connectors for 4-16 ohms or 70V and 100V speaker
- 14. MUTE ADJUSTMENT
Adjusts the mute level from 0-20 dB during signal override of all channels by MIC1 input
- 15. MIC1 INPUT
Compatible with XLR and 1/4" phono plugs
- 16. MIC 1 PHANTOM
+48V Power switch
- 17. MIC 2 INPUT
Compatible with 1/4" phono plug
- 18. AUX INPUT
Compatible with RCA plug
- 19. LINE OUT
Compatible with RCA plug
- 20. TEL INPUT G/-/+

4. CONNECTIONS

4.1 SPEAKER CONNECTIONS

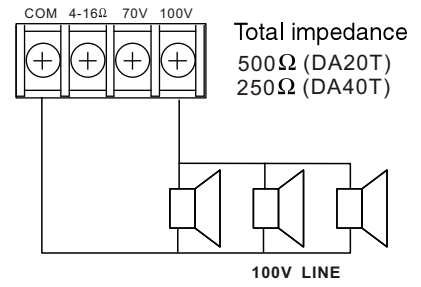
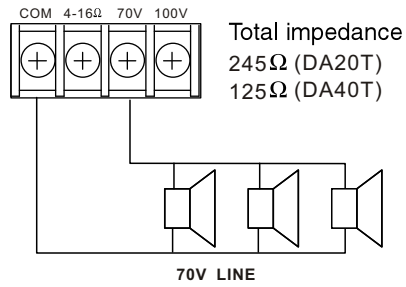
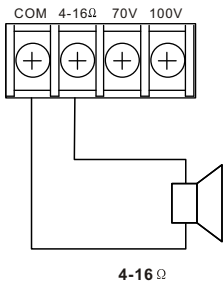

Notes

- The 4-16 ohm and 70V/100V terminals cannot both be used at the same time.
- Impedances indicated in the figures represent the total speaker system (load) impedances.

WARNING

Be sure to replace the speaker terminal cover after speaker connections have been made.

4.2 XLR CONNECTIONS

Combined XLR (female)/phone jack connectors.

Usable connectors and plugs

- XLR type male connector

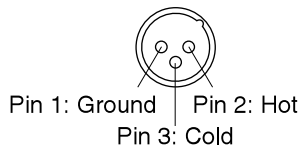

- Phone plug

Sleeve: Ground

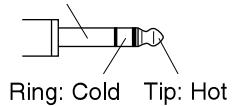

5. OPERATION

OPERATION

You can only choose two of the four output connectors to work together. If voltage is 70V/100V the speakers must have a transformer, make sure the total power wattage of speaker is 15% less than the power wattage of amplifier.

TROUBLESHOOTING

Problems	Cause
All wires are connected properly but there is no audio output	<ol style="list-style-type: none">1. No power or wrong connection2. Fuse is blown3. Volume is turned off4. No input signal
Alarm sounds when power is turned on	<ol style="list-style-type: none">1. Overloading or short circuit2. Voltage is not stable, too high or low
No output	<ol style="list-style-type: none">1. Product is in protection mode due to high temperature or malfunction2. Wrong wiring or connections

MUTE FUNCTION

1. TEL has priority over all inputs.
2. MIC 1 is second priority, adjusting the mute level can override all other input signals except for the tel signal.

6. APPLICATIONS

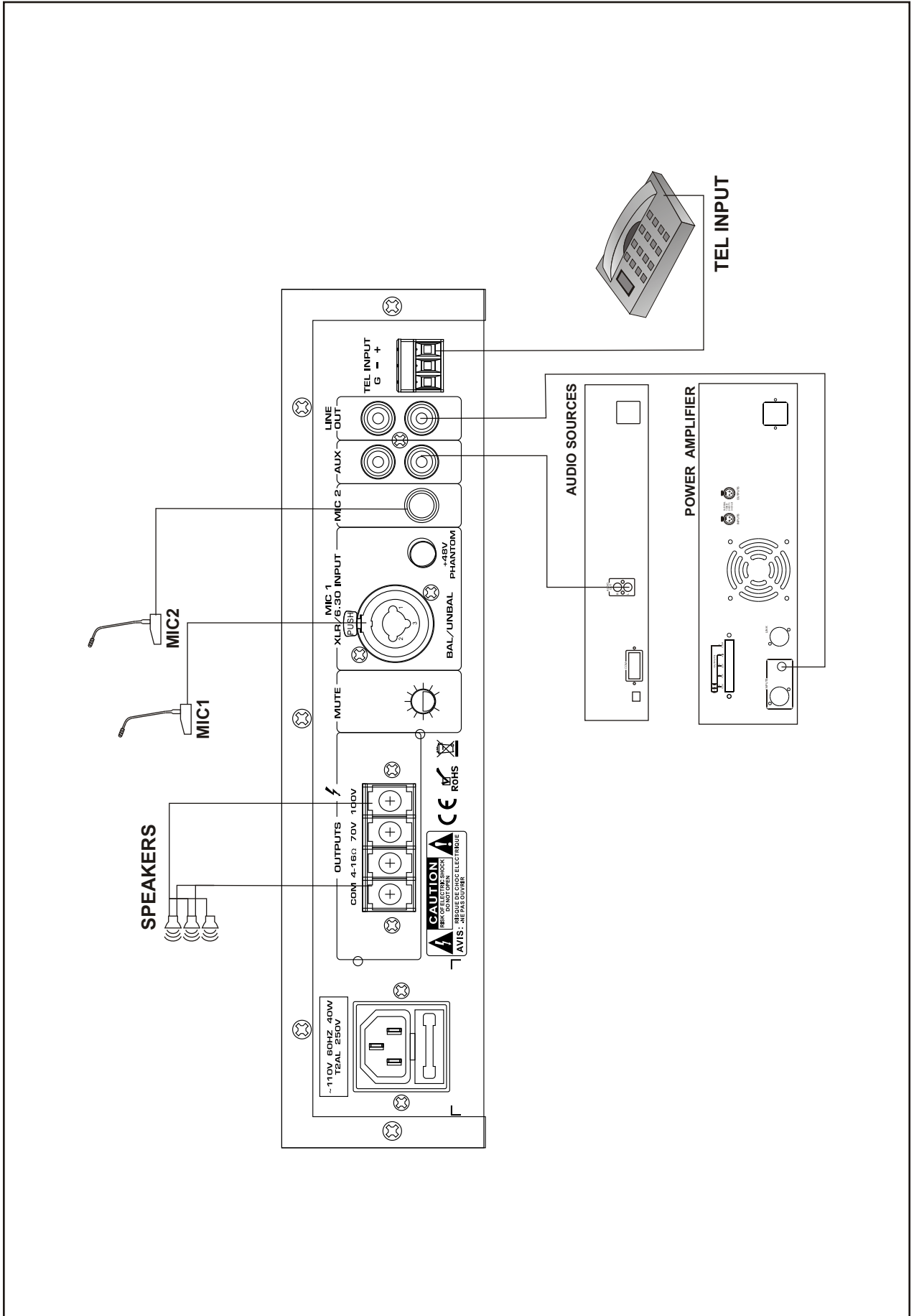

7. APPLICATION DIAGRAM

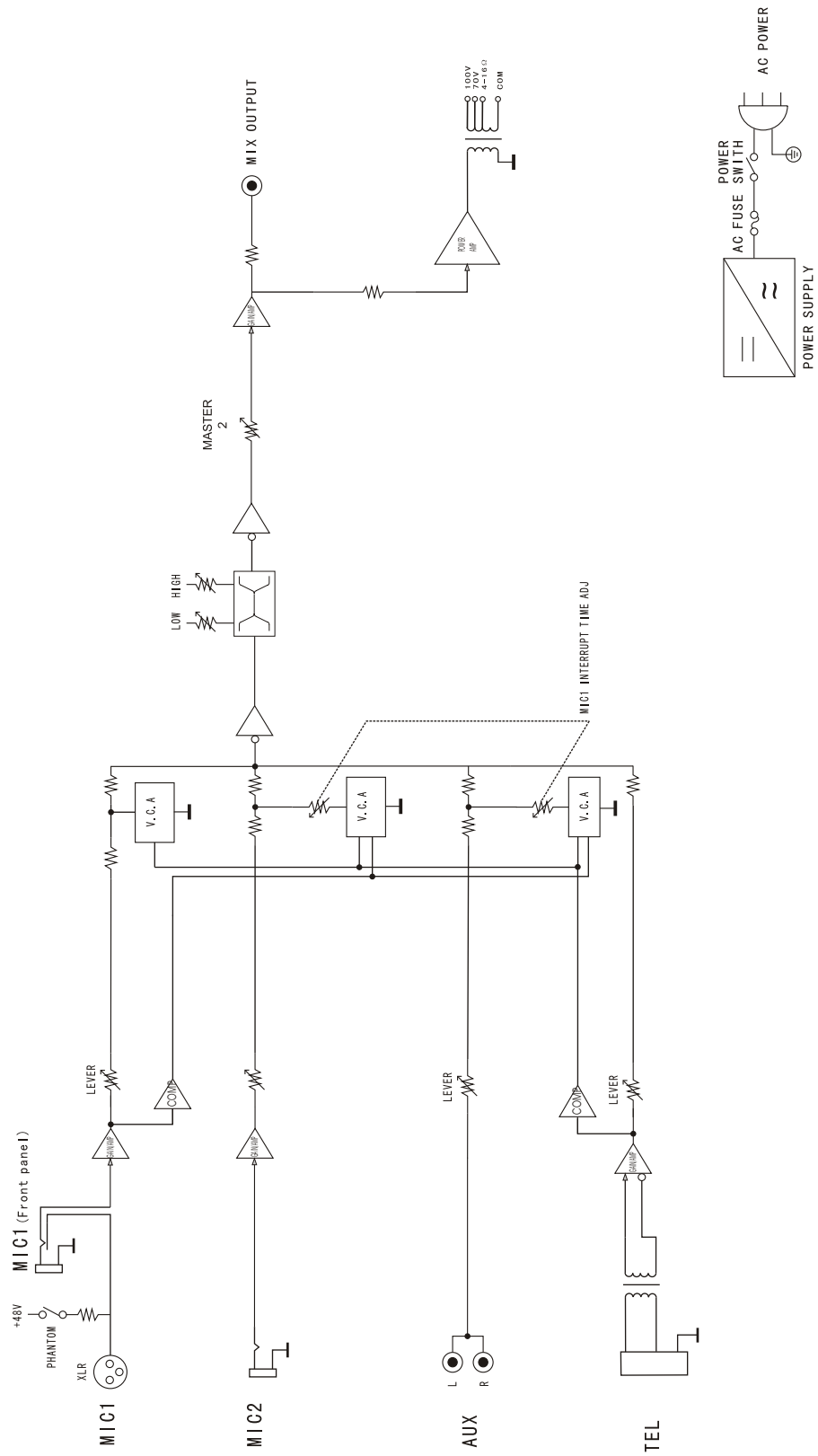

8. SPECIFICATIONS

MIXER AMPLIFIER		
Model	DA20T	DA40T
Rated Power Output	20W	40W
Speaker Output	4~16 Ω , 70V, 100V	
S/N	MIC: 66 dB; AUX: 80 dB	
Frequency response(At 1kHz half-power output, -3dB)	80 Hz~16 kHz	
Tone control(Bass:100 Hz, Treble:10 kHz)	± 10 dB	
Input sensitivity/impedance	MIC1,2: 5 mV/1k ohms AUX: 350 mV/10k ohms TEL: 350 mV/10k ohms	
MIC 1~2 input section(CH1~2 in@1KHz, preamp out)		
Input sensitivity/impedance	5 mV/1k ohms	
AUX 1 input section(AUX in@1KHz, preamp out)		
Input sensitivity/impedance	350 mV/10k ohms	
TEL input section(TEL in@1KHz, preamp out)		
Input sensitivity/impedance	350 mV/10k ohms	
Phantom power	+48 VDC	
Line Out	1000mV/470 ohms	
Total harmonic distortion	Less than 0.5%	
Muting function	TEL takes precedence over all the audio input MIC1 prior to the other audio input (except TEL)	
Channel crosstalk(Separation)	50 dB	
Cooling mode	Air cooling	
Power source	~110V 60 Hz	
Power consumption	40W	70W
Net weight	3.6 Kg	4.5 Kg
Dimensions(mm)	276 X 245 X 70	

9. DIMENSIONAL DIAGRAM

UNIT: mm

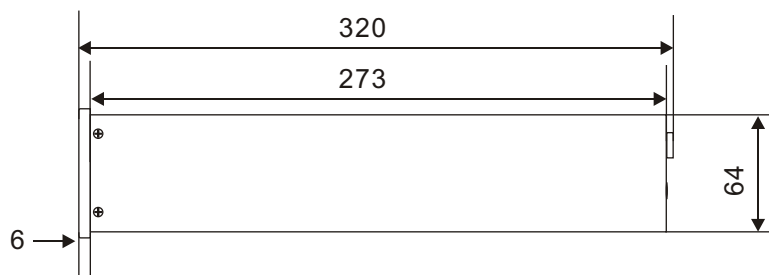
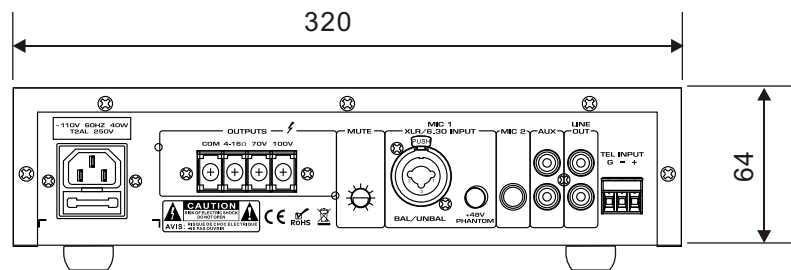
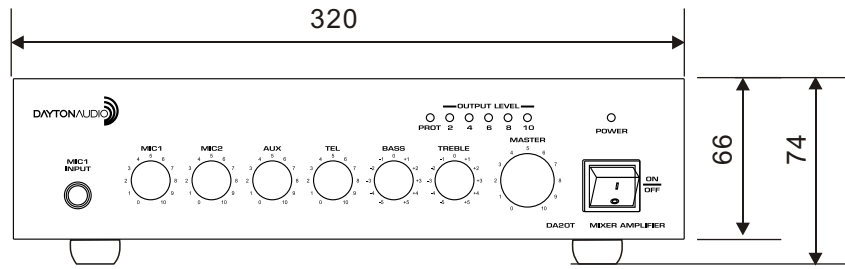

Keeps all sides of the product clear and free of objects that may obstruct the air flow and prevent proper cooling of the product.

UNIT: mm

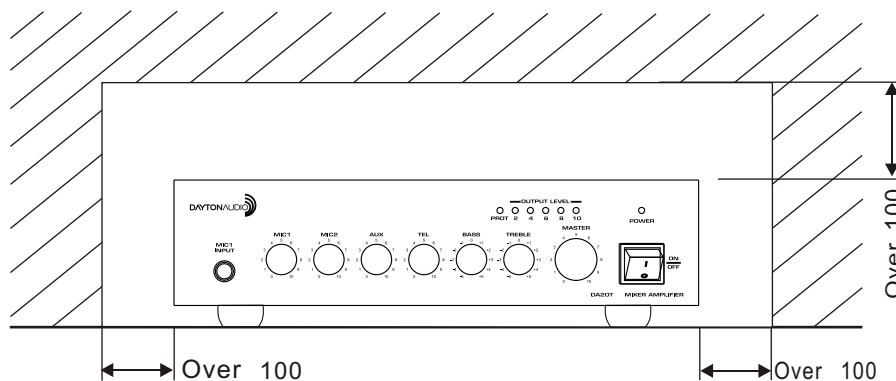

Warranty Information

Dayton Audio products are warranted free from defects in material and workmanship for **5 years** from date of purchase (see exceptions below). In the rare case of a product failure, please contact your place of purchase or call our Customer Support Department at (937) 743-8248.

Warranty Limitations

There are no other warranties, either express or implied, that extend the foregoing, and there are no warranties of merchantability or fitness for any particular purpose. Dayton Audio is not responsible for any consequential or inconsequential damage to any other unit or component or the cost for installation or extraction of any component of the audio system, or for the improper use of products. This includes but is not limited to burnt voice coils, overheating, bent frames, holes in the cone, or broken lead wires. Warranty does not apply to misuse, abuse, neglect, accident, improper use, etc. Dayton Audio reserves the right to repair or replace the products with either a new or factory refurbished unit.

Exception: Dayton Audio HDMI Cables -- No registration, no questions asked LIFETIME warranty. Replacement of Dayton Audio HDMI cables is with equal or better quality HDMI cables. Unassembled Kits - A 45-day return policy applies to unassembled kits. Once assembly has been started or completed, kits are deemed used and are nonreturnable for refund/exchange. This does not limit the manufacturers' warranty policies on any kit component.

This warranty gives you specific legal rights and you may also have other rights that vary from state to state.

Non-Warranty Service: If non-warranty service is required, the product may be sent to the Company for repair/replacement, transportation prepaid, by calling (937) 743-8248 for details, complete instructions, and service fee charges.



daytonaudio.com
tel + 937.743.8248
info@daytonaudio.com

705 Pleasant Valley Dr.
Springboro, OH 45066
USA